

DECEMBER 2023

LISTINO PREZZI - NOVITÀ

PRICE LIST - NEWS

VETRINA DELLE NOVITÀ

NEWS SHOWCASE



SISTEMA DI CONTINUITÀ CON ACCUMULO

Cablato in cabinet da esterno IP55, installazione a palo e parete

DC UPS POWER SYSTEM WITH BATTERY

IP55 cabinet plug and play, outdoor installation on lamp mast or wall

COMBY CAB 12-24-48Vdc

COMBY CAB MINI 12-24-48Vdc

→ | PAG. 12-13
CAP. 33-34



ALIMENTATORI INGRESSO TRIFASE - BIFASE

USCITA 24V - 48V FINO 960W

3-PHASES / 2-PHASE POWER SUPPLIES

OUT 24V - 48V UP TO 960W

TOP-R RT → | PAG. 6
CAP. 16



ALIMENTATORE DI CONTINUITÀ 2 VIE RACK 19"

Monitoraggio stati operativi, test batteria da remoto

2-WAYS RACK 19" POWER SUPPLIES

Local and remote control
Battery test by remote

HP-RM 12V - 24V - 48V - 110Vdc → | PAG. 4
CAP. 10

ALIMENTATORI DI CONTINUITÀ DA BARRA DIN

2-WAYS DIN BAR POWER SUPPLIES

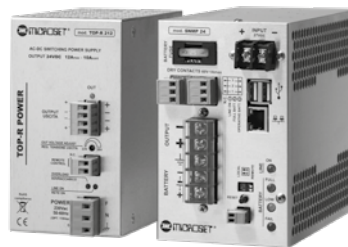

Controllo a microprocessore, caricabatterie integrato o in uscita separata, versione SNMP

Battery management, on board or separate unit battery charger, SNMP version

HDS-B → | PAG. 7
CAP. 19

TOP-R / HS SNMP → | PAG. 8
CAP. 22

ESTENSORI DI CAMPO PER TELEFONIA MOBILE MULTIBANDA E MULTIOPERATORE

2G - 4G - 5G

MOBILE TELEPHONE EXTENDERS MULTIBAND AND MULTIPROVIDERS

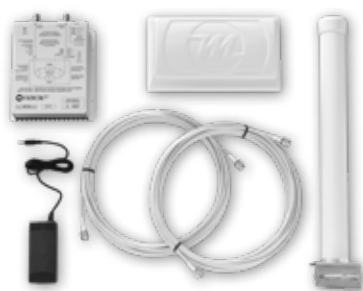

BT20 DUAL-OM



COLLINEAR ANTENNAS

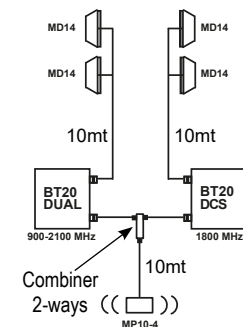

3 BAND COL2 900-1800-2100

MULTIBAND SYSTEMS → | PAG. 24-25
CAP. 55-56

ANTENNAS → | PAG. 27
CAP. 59-60-61

CAP. 1

ALIMENTATORI DA LABORATORIO

 Doppia regolazione di tensione larga e fine
 Corrente di uscita regolabile e preselezionabile
 Stacco rapido del carico di uscita

Mod. LT 100S	Uscita	0-40Vdc 0-20A	[cod. 1002159].....Euro	600,00
Mod. LT 200S	Out	0-15Vdc 0-25A	[cod. 1002067].....	" 575,00
Mod. LT 60S	"	0-60Vdc 0-5A	[cod. 1002157].....	" 635,00

new Mod. LT 12-9	Uscita	60-120Vdc 0-9A	[cod. -----].....Euro	750,00
--------------------------------	--------	-----------------------	-----------------------	---------------

Alimentatore con display LCD a colori multifunzione
 Power supply with multifunction LCD colour display

Opzioni:
new KIT CAVI DI COLLEGAMENTO rosso-nero

Mod. BAN-CO 16A R-N	1.1mt 2,5mm ² banana-crocodile plug [cod. 10020118].....Euro	80,00
----------------------------	---	--------------

Optional:

WIRING CONNECTION KIT red-black

HIGH PERFORMANCE LAB POWER SUPPLIES

 Out Voltage Double accuracy adjustment
 Out Current pre-set and adjustment
 Load fast stand-by



CAP. 2

ALIMENTATORI DI GROSSA POTENZA
REGOLAZIONE TENSIONE E CORRENTE

Dimensioni compatte, alte prestazioni, servizio 24h

HEAVY
CYCLE
HIGH CAPACITY POWER SUPPLIES
VOLTAGE AND CURRENT ADJUSTMENT

Compact size, high resolution, cycle 100%

 DOUBLE
 INSULATION 

 Protezioni: sovraccarico, sovratemperatura, cortocircuito accidentale,
 ottima immunità ai radiodisturbi

 Protections: shortcircuit, overtemperature,
 overload, excellent EMI filtering

Mod. LT 190	Uscita	5-15Vdc 24-90A	[cod. 1002202].....Euro	585,00
Mod. LT 250	Out	4-30Vdc 10-50A	[cod. 1002209].....	" 590,00
Mod. LT 430	"	5-60Vdc 10-30A	[cod. 1002210].....	" 590,00



CAP. 3

ALIMENTATORI STABILIZZATI
DI ALTA QUALITÀ

USO RADIO TELECOM - LABORATORIO E TEST

Piccoli, potenti, silenziosi e affidabili

STABILIZED HIGH QUALITY
POWER SUPPLIES

RADIO TELECOM - LAB & GENERAL PURPOSE

Small size, powerful, reliable and silent.

 DOUBLE
 INSULATION 

Mod. LS 40	Uscita	4-15Vdc 40A	[cod. 10021107].....Euro	320,00
Mod. LS 50	Out	4-15Vdc 55A	[cod. 10021111].....	" 395,00
Mod. LS 430	"	4-30Vdc 30A	[cod. 10021109].....	" 450,00



Gioielli tecnologici, alta efficienza.

High technology, high efficiency.

 Protezione totale: cortocircuito, sovratemperatura,
 sovraccarico, sovratensioni

 Full protections: shortcircuit, overtemperature,
 overload, overvoltage

VERSIONI USCITA TENSIONE FISSA
FIX OUTPUT VOLTAGE VERSIONS

new Mod. TOP-T 25	Uscita/Out	13.5Vdc 25A max	[cod. 1002301].....Euro	215,00
Mod. TOP-T 40	"	13.5Vdc 40A max	[cod. 1002303].....	" 280,00

 Compatto mini-tower, rete universale 110-230Vac
 [25A] senza ventilatore
 [40A] ventilatore con > 20A carico

 Compact size mini-tower, power range 110-230Vac
 [25A] blower less
 [40A] blower on with load > 20A

RADIO
TRAVEL
PARTNER

Mod. LTS 150	Uscita	13.5Vdc 55A	[cod. 10021108].....Euro	320,00
Mod. LTS 230	Out	24Vdc 30A	[cod. 10021110].....	" 365,00



Protezione totale, ventola a velocità controllata

Full protection, blower with speed control

CAP. 4

CARICO FITTIZIO ELETTRONICO
IN CORRENTE CONTINUA

Test batterie, celle fotovoltaiche, alimentatori

D.C. ELECTRONIC DUMMY LOAD

 Batteries, solar panels and
 power supplies test

Mod. DL 10C	Load range	0-10A 0-40V	[cod. 1004007].....Euro	400,00
--------------------	------------	--------------------	-------------------------	---------------

 Sistema a tensione e corrente costante.
 Alta risoluzione 100mA.

 Constant voltage and current system.
 High resolution 100mA.

LINEAR TECHNOLOGY

CAP. 5

ALIMENTATORI LINEARI A BASSO RIPPLE

Per usi generali - Tensione fissa e regolabile

Mod. L200A	Uscita	13.5Vdc	2A	[cod. 1002016].....Euro	50,00
Mod. P107A	Out	"	7-8A	[cod. 1002018].....	" 115,00
Mod. CS35A	"	0-15Vdc	3.5-4A	[cod. 1002031].....	" 75,00
Mod. PS 105A	"	"	5-6A	[cod. 1002013].....	" 150,00

LINEAR POWER SUPPLIES - LOW RIPPLE

General purpose - Fix and adjustable out voltage



CAP. 6

ALIMENTATORI STABILIZZATI
USCITA TENSIONE FISSA PER TELECOMUNICAZIONI

Protezione totale - Totale assenza di radiodisturbi

STABILIZED POWER SUPPLIES
TELECOM USE

Full protection - Totally interferences less

Mod. PT110A	Uscita	13.5Vdc	10A - 7A cont	[cod. 1002036].....Euro	235,00
Mod. PT120	Out	"	20A - 12A cont	[cod. 1002039].....	" 320,00
new Mod. PT135B	"	"	35A - 22A cont	[cod. 10020120].....	" 398,00

Alta stabilità, basso ripple. Protezione al cortocircuito e sovratensione in uscita. Ottima immunità ai fulmini in rete. Senza ventilatore.

High stability, low ripple, crow bar and short circuit protection. Excellent storm lightning immunity. Blower less.



CAP. 7

ALIMENTATORI LINEARI DI CONTINUITÀ
INTERFACCIA BATTERIA ESTERNA

USO TELECOMUNICAZIONI PROFESSIONALI

D.C. POWER SUPPLIES No break system
FLOATING BATTERY INTERFACE

PROFESSIONAL TELECOM USE

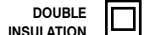

Mod. PT114A	Uscita	13.5Vdc	14A charger 2-4A	[cod. 1002037].....Euro	260,00
Mod. PT135IB	Out	"	35A " 5-7A	[cod. 1002080].....	" 435,00

Collegamento batteria esterna dal basso. Protezione al cortocircuito e sovratensioni in uscita. Affidabilità oltre 15 anni.

External battery connection on the rear. Protections: shortcircuit and crowbar. Top operative life over 15 years.



CAP. 8

ALIMENTATORI LINEARI
CON ALLOGGIAMENTO TRANSCEIVER

Trasformano il veicolo in base fissa

LINEAR POWER SUPPLIES
TRANSCEIVER FRAME

From mobile to desk base station

Mod. PM110	Uscita	13.5Vdc	10A	[cod. 1002068].....Euro	250,00
-------------------	--------	----------------	------------	-------------------------	---------------

Solo alloggiamento TRX, only TRX frame

Mod. PM110A	Out	13.5Vdc	10A	[cod. 1002084].....	" 280,00
--------------------	-----	----------------	------------	---------------------	-----------------

Con altoparlante, with loudspeaker

Mod. PM112AB	"	13.5Vdc	10A	[cod. 1002224].....	" 380,00
---------------------	---	----------------	------------	---------------------	-----------------

 Alimentatore con alloggiamento transceiver, altoparlante, batteria 12V 7Ah, test batteria
 Power supply with transceiver frame, loudspeaker, battery 12V 7Ah, battery test

RADIO TELECOM
SPECIAL

PM112AB

ALIMENTATORE con altoparlante
e batteria interna di continuità

POWER SUPPLY - loudspeaker
battery on board

Mod. PT112AB	Uscita/Out	13.5Vdc	10A charger 1A	[cod. 1002225].....Euro	315,00
---------------------	------------	----------------	------------------------------	-------------------------	---------------

Altoparlante, batteria 12V 7Ah, test batteria.

Loudspeaker, battery 12V 7Ah, battery test.



PT112AB

CAP. 9

ALIMENTATORE LINEARE
CON INTERFACCIA BATTERIA
TRASFORMATORE TOROIDALE

Telecomunicazione - Automazione - Medicali

Completa protezione ai radio disturbi



STABILIZED D.C. POWER SUPPLIES
FLOATING BATTERY INTERFACE
TOROIDAL TRAF0

Radio communication - Industrial use - Medical

Full protection against noise emission

Mod. IP512 I-B	Uscita/Out	13.5Vdc	5A charger 0.7A	[cod. 1002082].....Euro	198,00
-----------------------	------------	----------------	-------------------------------	-------------------------	---------------

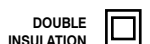
Mod. IP324 I-B	"	28Vdc	3A " 0.3A	[cod. 1002083].....	" 198,00
-----------------------	---	--------------	-------------------------	---------------------	-----------------



CAP. 10

ALIMENTATORI DI CONTINUITÀ DUE VIE
BATTERIA TAMPONE - RACK 19"
STACCO AUTOMATICO BATTERIE SCARICHE

 Controllo a microprocessore, Allarme batteria esausta
AC-DC POWER SUPPLIES 19" RACK PLUG-IN
FLOATING BATTERY - NO BREAK
DISCHARGED BATTERY SHUT DOWN

 Microprocessor control, Exhausted battery alarm

2 UNITS RACK 19" - P/D 210 mm



NEW 2 UNITS RACK 19" - HEAVY LOAD (HL)

Colore pannello frontale

Front panel colour:

Nero/Black (B)

Grigio/Grey (G)

Mod.	Uscita	13,5Vdc	14A	charger	4-5A	(G)[cod. 1002182]	(B)[cod. 1002182N].....	Euro	520,00
◦ Mod. HP 114RM	Out	"	25A	"	6-7A	(G)[cod. 1002183]	(B)[cod. 1002183N].....	"	630,00
# Mod. HP 135RM	"	"	35A	"	10A	[cod. 10021116].....		"	640,00
Mod. HP 155RM	"	"	55A	"	10-15A	[cod. 10021100].....		"	740,00
Mod. HP 175RM	"	"	75A	"	10-15A	[cod. 1002240].....		"	860,00
# Mod. HP 220RM	"	24Vdc (28V)	25A	"	5-6A	(G)[cod. 1002192]	(B)[cod. 1002192N].....	"	690,00
Mod. HP 230RM	"	"	30A	"	6-7A	[cod. 1002227].....		"	765,00
<u>HL</u> Mod. HP 265RM	"	"	60A	"	13-15A	[cod. 10021115].....		"	1.085,00
# Mod. HP 410RM	"	48Vdc (56V)	12A	"	3-4A	(G)[cod. 1002197]	(B)[cod. 1002197N].....	"	705,00
Mod. HP 420RM	"	"	25A	"	6-7A	[cod. 1002228].....		"	850,00
<u>HL</u> Mod. HP 445RM	"	"	40A	"	9-10A	[cod. 10021114].....		"	1.085,00
<u>HL</u> Mod. HP 12-18RM	"	110Vdc (124V)	18A	"	3-4A	[cod. 10020121].....		"	1.095,00

- Trafo di isolamento a bordo contro scariche atmosferiche.

Controllo locale e remotabile (CONTATTI SECCHI): rete ON/OFF, batteria carica-scarica-scollegata o esausta.

- On board input insulation trafo lightning protection.

Local and remote control (DRY CONTACTS): line ON/OFF, charged-discharged - battery failure.

Opzioni:

- Rete 110V 60Hz
- Rete di ingresso estesa 230Vac ±20% per uso in zone disagiate
- Trasformatore d'ingresso #
- Caricabatteria maggiorato
- Combinatore parallelo 2 vie (1+1)

Optional:

- Power 110V 60Hz Euro **80,00**
- Extended input line 230Vac ±20% for use in remote areas **185,00**
- Input galvanic trafo # **205,00**
- Powerful battery charger **90,00**
- 2 ways parallel combiner (1+1)**

- 12V 55A - 24V 30A - 48V 20A MAX [cod. 1002401]..... **165,00**
- 12V 75A - 24V 60A - 48V 40A - 110V 12A [cod. 1002405]..... **275,00**

 Mod. **SL6** Selettore di distribuzione - *Distributor selector* [cod. 10021102]..... **165,00**

1 ingresso - 6 uscite selezionabili - 1 input - 6 selectable outputs

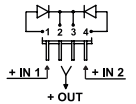

PARALLEL COMBINER

 SL6 - 6 WAYS OUTPUTS
 Fuses: 4 x 20A - 2 x 10A

CAP. 11

ALIMENTATORI DI CONTINUITÀ
CONTROLLO REMOTO VIA INTERNET
BATTERIA TAMPONE - RACK 19"

new
SNMP

 Accensione e spegnimento da remoto
 Segnalazioni anomalie, uscita RJ45

POWER SUPPLIES D.C. UPS RACK PLUG-IN
INTERNET REMOTE CONTROL
FLOATING BATTERY - NO BREAK

 Turn ON-OFF by remote internet control
 Faulty alarm database, RJ45 connection

Controlli a distanza in modalità REMOTA - SNMP:

- Operatività da rete o batteria
- Livello di carica della batteria
- Misura tensione e corrente di uscita
- Temperatura operativa
- Test batterie • Accensione - spegnimento carico



2 UNITS RACK 19"

Monitoring and control by REMOTE-SNMP:

- Line operating or battery
- Battery charging level
- Output voltage and current metering
- Operative temperature
- Battery test • Turn ON - OFF load

Mod.	Uscita	13.5Vdc	25A	charger	4-5A	[cod. 10021106].....	Euro	1.210,00
Mod. HP125SNMP	Out	24Vdc (28V)	20A	"	6-7A	[cod. 10021105].....	"	1.265,00
Mod. HP410SNMP	"	48Vdc (56V)	10A	"	3-4A	[cod. 10021103].....	"	1.265,00
Mod. HP420SNMP	"	"	20A	"	5-6A	[cod. 10021104].....	"	1.495,00
Mod. HP440SNMP	"	"	40A	"	7-8A	[cod. 10021112].....	"	2.025,00

CAP. 12

STAZIONI DI ENERGIA
CORRENTE CONTINUA 12-24-48-110Vdc
SEMPRE OPERATIVE IN TEMPO ZERO
BATTERIE PROFESSIONALI LUNGA VITA

Efficienti e sicure stazioni di energia per alimentare con elevata affidabilità apparati e sistemi sensibili, sia in presenza che in assenza rete, per breve e lungo tempo.

- Gestione totalmente automatica
- Controllo remoto - SNMP Opzionale
- Allarme batteria esausta
- Batterie LONG LIFE 10 anni

APPLICAZIONI TIPICHE:

- Reti telefoniche
- Ponti radio
- Videosorveglianza
- Sicurezza
- Riarmo cabine elettriche media-alta tensione
- Luci scialitiche per sale operatorie

**NEW SNMP
VERSION**

D.C. POWER UNITS
OUTPUT 12-24-48-110Vdc
EMERGENCY NO-BREAK SYSTEM
PROFESSIONAL LONG LIFE BATTERIES

Efficient and very reliable D.C. power source units able to supply hi-tech D.C. equipments for short and long black-out.

- Full automatic management
- Local and remote control - SNMP facility
- Exhausted battery alarm
- LONG LIFE batteries 10 years

TYPICAL APPLICATIONS:

- Switchers
- Radio links and transmitters
- Safety
- Security
- Electric high voltage breakers
- Scialytic lights for clinic rooms

Mod.	Uscita alimentatore Power supply output Vdc A		Capacità batterie Battery capacity	Aut. ore Aut. hours	Dim. LxPxH Size WxDxH cm	Product Code	Prezzo Price
M 1225/40	13.5	25	40Ah	1	53x45x50	1026028	Euro 1.440,00
M 1225/65	13.5	25	65Ah	2	"	1026015	" 1.550,00
M 1225/130	13.5	25	120-130Ah	5	"	1026003	" 1.680,00
M 2420/24	24 (28V)	20	24-26Ah	1	"	1026034	" 1.620,00
M 2420/40	24 (28V)	20	40Ah	2	"	1026005	" 1.740,00
M 2420/65	24 (28V)	20	65Ah	3	"	1026006	" 2.160,00
M 2420/130	24 (28V)	20	120-130Ah	8	"	1026007	" 2.460,00
M 2460/160	24 (28V)	60	160-170Ah	5	53x45x104	1026008	" 3.900,00
M 2460/235	24 (28V)	60	200-235Ah	10	53x45x124	1026035	" 4.200,00
M 4812/40	48 (56V)	10	40Ah	5	53x45x50	1026010	" 2.280,00
M 4812/65	48 (56V)	10	65Ah	7	53x45x104	1026011	" 2.700,00
M 4820/65	48 (56V)	20	65Ah	3	"	1026020	" 2.870,00
M 4820/65 SNMP	48 (56V)	20	65Ah	3	"	1026036	" 3.510,00
M 4820/130	48 (56V)	20	120-130Ah	8	"	1026012	" 3.550,00
M 4820/130 SNMP	48 (56V)	20	120-130Ah	8	"	1026037	" 4.195,00
M 4840/130	48 (56V)	40	120-130Ah	2	"	1026021	" 3.850,00
M 4840/235	48 (56V)	40	200-235Ah	4	53x45x124+50	1026025	" 5.950,00
M 110-12-24	110 (124V)	15	24-26Ah	2	53x45x104	1026016	" 3.360,00
M 110-12-40	110 (124V)	15	40Ah	3	"	1026017	" 3.750,00
M 110-30-65	110 (124V)	30	65Ah	2	53x45x124	1026027	" 5.650,00

Opzioni:

- SNMP interfaccia di rete per controllo via internet
- Trasformatore di isolamento antifulmine: vd. pag. 21
- DC-DC converter stabilizzatore: vd. pag. 10
- Selettore di distribuzione **SL6**, 6 uscite selezionabili: vd. pag. 4

Disponibili altri modelli allestibili su richiesta.

Optional:

- SNMP remote network interface
- Input insulation trafo: see pag. 21
- DC-DC stabilizer converter: see pag. 10
- Distributor selector **SL6**, 6 selectable outputs: see pag. 4

Available more models on request.

RAIL DIN BAR

CAP. 13

ALIMENTATORI STABILIZZATI REGOLABILI
CONTROLLO REMOTO (mancanza di rete)
 Senza ventilatore, M.T.B.F. 100.000 ore, scaricatori di rete
 Protezione al cortocircuito

AC-DC STABILIZED ADJUSTABLE POWER SUPPLIES
REMOTE CONTROL (main failure)
 Blower less, M.T.B.F. 100.000h, lightning protection
 Short circuit protection

Mod. TOP-R 058/U	Uscita	5Vdc	(5÷8V)	8-10A	(60W)	[cod. 1002267].....Euro	75,00
Mod. TOP-R 098/U	Out	9Vdc	(9÷12V)	"	(110W)	[cod. 1002268]..... "	80,00
Mod. TOP-R 105/U	"	12Vdc	(12÷15V)	5A	(75W)	[cod. 1002255]..... "	75,00
Mod. TOP-R 108/U	"	"	"	8-10A	(150W)	[cod. 1002249]..... "	85,00
Mod. TOP-R 120	"	"	"	16-20A	(300W)	[cod. 1002221]..... "	180,00
Mod. TOP-R 205/U	"	24Vdc	(22÷28V)	5A	(140W)	[cod. 1002251]..... "	85,00
Mod. TOP-R 212	"	"	"	10-12A	(330W)	[cod. 1002222]..... "	180,00
Mod. TOP-R 403/U	"	48Vdc	(42÷60V)	2-3A	(160W)	[cod. 1002253]..... "	100,00
Mod. TOP-R 408	"	"	(38÷57V)	6-8A	(440W)	[cod. 1002223]..... "	185,00

/U: Universal Input power 98-265Vac

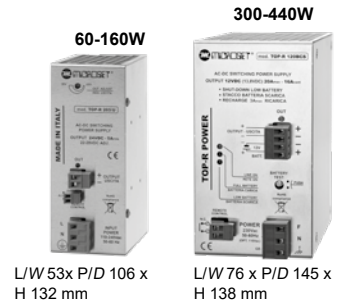
 DOPPIO ISOLAMENTO  DOUBLE INSULATION

CAP. 14

ALIMENTATORI STABILIZZATI ALTA EFFICIENZA
MEDIE E GROSSE POTENZE
SERVIZIO CONTINUO, Ventilazione controllata
 Protezione al cortocircuito, sovraccarico, sovratensione
 M.T.B.F. 100.000 ore

AC-DC HIGH EFFICIENCY POWER SUPPLIES
MEDIUM AND LARGE POWER
CONTINUOUS SERVICE, Blower speed control
 Protections: shortcircuit, overload, overvoltage
 M.T.B.F. 100.000 hours

Mod. HS 135	Uscita	13.5Vdc	35A	(480W)	Size A	[cod. 1002160].....Euro	270,00
Mod. HS 155	Out	"	55A	(750W)	" B	[cod. 1002269]..... "	310,00
Mod. HS 190	"	"	90-95A	(1200W)	" B	[cod. 1002241]..... "	450,00
Mod. HS 225	"	24Vdc	25A	(600W)	" A	[cod. 1002151]..... "	260,00
Mod. HS 250	"	"	50A	(1300W)	" B	[cod. 1002200]..... "	450,00
Mod. HS 412	"	48Vdc	12-15A	(800W)	" A	[cod. 1002161]..... "	320,00
Mod. HS 420	"	"	20-25A	(1200W)	" B	[cod. 1002230]..... "	415,00
Mod. HS 430	"	"	30-35A	(1700W)	" B	[cod. 1002235]..... "	450,00

 Robusta struttura in alluminio IP20.
 Regolazione interna della tensione di uscita.

 Rugged aluminium box IP20.
 Voltage adjustment facility.

 Size A L/W 240 x P/D 152 x H 100 mm.
 Size B L/W 275 x P/D 191 x H 134 mm.

 DOPPIO ISOLAMENTO  DOUBLE INSULATION

CAP. 15

ALIMENTATORI STABILIZZATI ALTA EFFICIENZA
MEDIE E GROSSE POTENZE, TENSIONE REGOLABILE
SERVIZIO CONTINUO, Ventilazione controllata
 INSTALLAZIONE BARRA DIN

AC-DC HIGH EFFICIENCY POWER SUPPLIES
MEDIUM AND LARGE POWER, OUT VOLTAGE ADJUSTMENT
CONTINUOUS SERVICE, Blower speed control
RAIL BAR INSTALLATION

Mod. HDS 135	Uscita	13.5Vdc	(10÷15)	35A	(500W)	Size A	[cod. 1002270].....Euro	260,00
Mod. HDS 155	Out	"	(10÷15)	55A	(800W)	" B	[cod. -----]..... "	310,00
Mod. HDS 225	"	24Vdc	(22÷28)	25A	(700W)	" A	[cod. 1002271]..... "	275,00
Mod. HDS 235	"	"	(22÷28)	35A	(1000W)	" B	[cod. -----]..... "	350,00
Mod. HDS 412	"	48Vdc	(38÷57)	15A	(850W)	" A	[cod. 1002272]..... "	295,00
Mod. HDS 420	"	"	(38÷57)	20A	(1200W)	" B	[cod. -----]..... "	390,00
Mod. HDS 12-9	"	110Vdc	(100÷120)	9A	(1100W)	" B	[cod. -----]..... "	395,00

Rete universale 110-230Vac 50-60Hz

Universal input power 110-230Vac 50-60Hz

 Size A L/W 170 x P/D 90 x H 136 mm
 Size B L/W 267 x P/D 102 x H 177 mm

CAP. 16

ALIMENTATORI INGRESSO TRIFASE
INSTALLAZIONE BARRA DIN
 Ingresso 400Vac 50Hz trifase con possibilità bifase

THREE PHASES INPUT POWER SUPPLIES
RAIL BAR INSTALLATION
 Input 400Vac 50Hz 3-phase or 2-phase input

Mod. TOP-RT 210	Uscita	24Vdc	(22÷28)	10A	(250W)	[cod. 10021118].....Euro	250,00
Mod. TOP-RT 220	Out	24Vdc	"	20A	(480W)	[cod. 10021119]..... "	350,00
Mod. TOP-RT 240	"	24Vdc	"	40A	(960W)	[cod. 10021120]..... "	450,00
Mod. TOP-RT 405	"	48Vdc	(38÷57)	5A	(250W)	[cod. 10021117]..... "	250,00
Mod. TOP-RT 410	"	48Vdc	"	10A	(480W)	[cod. 10021121]..... "	320,00
Mod. TOP-RT 420	"	48Vdc	"	20A	(960W)	[cod. 10021122]..... "	450,00

Ingresso esteso 340-550Vac 50Hz, Senza ventilatore

Extended input line 340-550Vac 50Hz, Blower less

Opzioni: Cablaggio parallelo

 Optional: Parallel wiring [cod. 1002411]...Euro **80,00**

NO BREAK

CAP. 17

ALIMENTATORI DI CONTINUITÀ DUE VIE
INTERFACCIA BATTERIA DI SICUREZZA

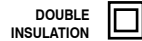
 Controllo remoto (mancanza di rete)
 Senza ventilatore - Scaricatori di rete
 Protezione al cortocircuito e sovraccarico

2 WAYS AC-DC POWER SUPPLIES
FLOATING BATTERY INTERFACE - NO BREAK

 Remote control (main failure)
 Blower less - Lightning protection
 Short circuit and overload protection

 M.T.B.F.
 100.000h

Mod. TOP-R 105BC/U	Uscita	13.5Vdc	5A (75W)	Charger	1A [cod. 1002256].....	Euro	95,00
Mod. TOP-R 108BC/U	Out	"	8-10A (150W)	"	2-3A [cod. 1002250].....	"	110,00
Mod. TOP-R 120BC	"	"	16-20A (300W)	"	3A [cod. 1002208].....	"	195,00
Mod. TOP-R 205BC/U	"	28Vdc	5A (140W)	"	0,9A [cod. 1002252].....	"	110,00
Mod. TOP-R 212BC	"	"	10-12A (330W)	"	2A [cod. 1002203].....	"	198,00
Mod. TOP-R 403BC/U	"	56Vdc	2-3A (160W)	"	0,4A [cod. 1002254].....	"	115,00
Mod. TOP-R 408BC	"	"	6-8A (440W)	"	1A [cod. 1002205].....	"	205,00

75-160W

 L/W 53x P/D 106 x
 H 132 mm

300-440W

 L/W 76 x P/D 145 x
 H 138 mm

/U: Universal Input power 98-265Vac

CAP. 18

ALIMENTATORI DI CONTINUITÀ DUE VIE
CONTROLLO E STACCO BATTERIE SCARICHE

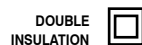
 Scaricatori di rete, senza ventilatore
 Test batterie, controllo a distanza
 Protezione al cortocircuito e sovraccarico

2 WAYS NO BREAK POWER SUPPLIES
BATTERY MANAGEMENT and SHUT DOWN

 Lightning protection, blowerless
 Battery test, remote control
 Short circuit and overload protection

 M.T.B.F.
 100.000h

Mod. TOP-R 120BCS	Uscita	13.5Vdc	16-20A (300W)	Charger	3A [cod. 1002206].....	Euro	215,00
Mod. TOP-R 120BCS+CB1	Out	"	"	"	6A [cod. 1002244].....	"	275,00
Mod. TOP-R 120BCS+CB2	"	"	"	"	9A [cod. 1002245].....	"	295,00
Mod. TOP-R 212BCS	"	28Vdc	10-12A (330W)	"	2A [cod. 1002204].....	"	220,00
Mod. TOP-R 212BCS+CB1	"	"	"	"	4A [cod. 1002233].....	"	295,00
Mod. TOP-R 212BCS+CB2	"	"	"	"	6A [cod. 1002246].....	"	315,00
Mod. TOP-R 408BCS	"	56Vdc	6-8A (440W)	"	1A [cod. 1002207].....	"	225,00
Mod. TOP-R 408BCS+CB1	"	"	"	"	2A [cod. 1002243].....	"	300,00
Mod. TOP-R 408BCS+CB2	"	"	"	"	4A [cod. 1002247].....	"	320,00

 L/W: 76 x P/D 145 x H 138 mm
 L/W (CB1): 96 x P/D 145 x H 138 mm
 L/W (CB2): 110 x P/D 145 x H 138 mm

Opzioni: Cambio tensione 230-110Vac

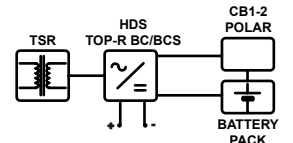
 Optional: 230-110Vac voltage switch.....Euro **80,00**

CAP. 19

ALIMENTATORI DI CONTINUITÀ DUE VIE
CONTROLLO A MICROPROCESSORE
STACCO BATTERIE SCARICHE

Remote control di stato batteria / rete

2 WAYS NO BREAK POWER SUPPLIES
MICROPROCESSOR CONTROL
SHUTDOWN LOW BATTERY

Remote control battery level / line failure

Mod. HDS-B 135	Uscita	13.5Vdc	35A (500W)	Charger	6A	Size A	[cod. 1002273].....	Euro	315,00
Mod. HDS-B 155	Out	13.5Vdc	55A (750W)	"	12A	"	B [cod. -----].....	"	420,00
Mod. HDS-B 225	"	28Vdc	25A (700W)	"	3A	"	A [cod. 1002274].....	"	325,00
Mod. HDS-B 235	"	28Vdc	35A (1000W)	"	6A	"	B [cod. -----].....	"	450,00
Mod. HDS-B 412	"	56Vdc	12A (850W)	"	3A	"	A [cod. 1002275].....	"	350,00
Mod. HDS-B 420	"	56Vdc	20A (1100W)	"	5,5A	"	B [cod. -----].....	"	490,00

Rete universale 110-230Vac 50-60Hz

Universal input power 110-230Vac 50-60Hz

 Size A L/W 170 x P/D 90 x H 136 mm
 Size B L/W 267 x P/D 102 x H 177 mm

CAP. 20

ALIMENTATORI DI CONTINUITÀ 2 VIE
CONTROLLO E STACCO BATTERIA SCARICA

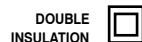
 Segnalazioni operative locali e remote
 Allarme mancanza rete - Ventilazione controllata
 Protezione al cortocircuito e sovraccarico

2-WAYS AC-DC POWER SUPPLY U.P.S.
BATTERY MANAGEMENT and SHUT DOWN

 Local and remote signalling
 Power failure alarm - Blower speed control
 Short circuit and overload protection

M.T.B.F. 100.000h

Mod. HSB 115	Uscita	13.5Vdc	15A (200W)	Charger	4A	Size A	[cod. 1002237].....	Euro	285,00
Mod. HSB 155	Out	"	55A (750W)	"	12A	"	B [cod. 1002236].....	"	435,00
Mod. HSB 225	"	24Vdc	25A (700W)	"	3A	"	A [cod. 1002242].....	"	315,00
Mod. HSB 235	"	(28V)	35A (1000W)	"	6A	"	B [cod. 1002232].....	"	490,00
Mod. HSB 420	"	(56V)	20A (1200W)	"	5,5A	"	B [cod. 1002238].....	"	515,00

Opzioni:

- CARICABATTERIA MAGGIORATO
 Tipo 1: 12A (12V), 6A (24V), 6A (48V)
 Tipo 2: 20A (12V), 10A (24V), 10A (48V)
- Rete 110Vac 60Hz

Optional:

- POWERFUL BATTERY CHARGER
 Type 1: 12A (12V), 6A (24V), 6A (48V).....Euro **90,00**
 Type 2: 20A (12V), 10A (24V), 10A (48V)..... " **150,00**
 Power 110Vac 60Hz " **80,00**

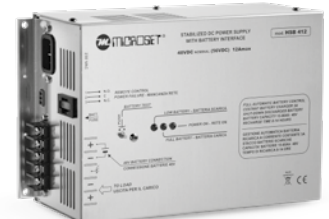
SERVICE H24
 Size A L/W 240 x P/D 152 x H 100 mm.
 Size B L/W 275 x P/D 191 x H 134 mm.

CAP. 21
SISTEMA DI CONTINUITA' COMBINATO
ALIMENTATORE – CARICABATTERIA CONTROLLORE
BATTERIA LUNGA VITA - AMPIA AUTONOMIA

Per telecamere e sicurezza

OPERATIVITÀ:

- Carica rapida in 6-8 ore
- Controllo locale e remoto
batteria carica - scarica
esausta da sostituire

PARTI FORNITE SFUSE:

- Alimentatore **TOP-R**
- Modulo caricabatterie **COMBY**
- Batterie professionali **HITACHI** o simili
- Conessioni

TOP-R **COMBY**
 2 x L/W 76 x P/D 145 x H 138 mm

DC UPS POWER SUPPLY COMBY
POWER SUPPLY - BATTERY CHARGER
LONG LIFE BATTERIES - LARGE AUTONOMY
CCTV and security use
OPERATIVE:

- 6-8 hours fast recharge
- Local and remote control of:
battery full - low
exhausted to change

DELIVERED PARTS TO ASSEMBLE:

- **TOP-R** Power supply
- **COMBY** Charger controller module
- **HITACHI** professional batteries or similar
- Wirings

Mod. COMBY 12-40	Uscita	13,5Vdc	16A	Charger	13A	Battery	12V	40Ah	Autonomy	18h load	2A	[cod. 10160120].....Euro	640,00
Mod. COMBY 12-65	Out	"	"	"	"	"	"	65Ah	"	"	3A	[cod. 10160117].....	725,00
Mod. COMBY 12-80	"	"	"	"	"	"	"	80Ah	"	"	4A	[cod. 10160114].....	795,00
Mod. COMBY 12-100	"	"	"	"	"	"	"	100Ah	"	"	5A	[cod. 10160111].....	830,00
Mod. COMBY 24-40	Uscita	27,5Vdc	10A	Charger	7A	Battery	24V	40Ah	Autonomy	18h load	1,8A	[cod. 10160109].....	845,00
Mod. COMBY 24-65	Out	"	"	"	"	"	"	65Ah	"	"	3A	[cod. 10160125].....	1.050,00
Mod. COMBY 24-80	"	"	"	"	"	"	"	80Ah	"	"	4A	[cod. 10160126].....	1.150,00
Mod. COMBY 48-24	Uscita	56Vdc	6A	Charger	4A	Battery	48V	24Ah	Autonomy	18h load	1A	[cod. 10160118].....	1.050,00
Mod. COMBY 48-40	Out	"	"	"	"	"	"	40Ah	"	"	2A	[cod. 10160116].....	1.260,00
Mod. COMBY 48-65	"	"	"	"	"	"	"	65Ah	"	"	3A	[cod. 10160129].....	1.600,00

Opzione: Trasformatore di protezione fulmini: vd. cap. 53

Optional: Insulation input trafo, spark lightning protection: see cap. 53

CAP. 22
ALIMENTATORI DI CONTINUITÀ 2 VIE
CONTROLLO REMOTO VIA INTERNET
ALIMENTATORE + UNITÀ CONTROLLER CARICABATTERIA
 Interfaccia batteria in tampone

2 WAYS DC UPS POWER SUPPLY
INTERNET REMOTE CONTROL
PSU UNIT + SNMP CONTROLLER UNIT
 Floating battery interface

- Installazione barra din
- Con cablaggio di collegamento e cavo di rete
- Software web integrato:
 - Segnalazione anomalie
 - Database MIB
 - Monitoraggio di tutti gli stati operativi

Controlli a distanza in modalità REMOTA - SNMP:

- Operatività da rete o batteria
- Livello di carica della batteria
- Misura tensione e corrente di uscita
- Temperatura operativa
- Test batterie
- Accensione - spegnimento carico

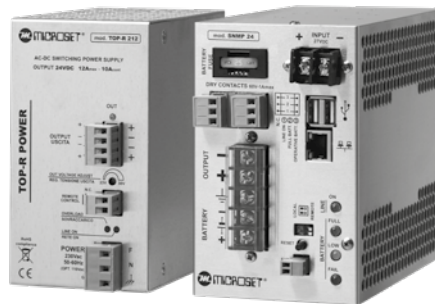
TOP-R or HS **SNMP**

- Din bar installation
- Wire connection and net cable provided
- Website software included:
 - Faulty alarms
 - MIB database
 - Operative status monitoring

Monitoring and control by REMOTE- SNMP:

- Line operating or battery
- Battery charging level
- Output voltage and current metering
- Operative temperature
- Battery test
- Turn ON - OFF load

Mod. TOP-R 120 SNMP	Uscita	13.5Vdc	16A	(300W)	Charger	7A	Size	1+4	[cod. 1002258].....Euro	680,00
Mod. HS 135 SNMP	Out	"	30A	(480W)	"	14A	"	2+4	[cod. 1002259].....	780,00
Mod. TOP-R 212 SNMP	"	24Vdc	10A	(700W)	"	5A	"	1+4	[cod. 1002260].....	690,00
Mod. HS 225 SNMP	"	(28V)	20A	(1000W)	"	10A	"	2+4	[cod. 1002261].....	770,00
Mod. TOP-R 408 SNMP	"	48Vdc	6A	(700W)	"	3A	"	1+4	[cod. 1002262].....	690,00
Mod. HS 412 SNMP	"	(56V)	10A	(1200W)	"	6A	"	2+4	[cod. 1002263].....	830,00
Mod. HS 420 SNMP	"	"	20A	(1200W)	"	6A	"	3+4	[cod. 1002264].....	935,00
Mod. HS 430 SNMP	"	"	30A	(1200W)	"	6A	"	3+4	[cod. 1002265].....	980,00

1: L/W 76 x P/D 145 x H 138 mm - 2: L/W 240 x P/D 152 x H 100 mm - 3: L/W 275 x P/D 191 x H 134 mm - 4: L/W 132 x P/D 87 x H 193 mm

CAP. 23

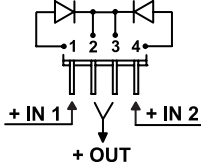
ACCESSORI DA BARRA DIN

 Mod. **DC 2 WAYS**Euro **95,00**
 [cod. 1002408]

Combinatore ridondante 2 vie
2 ways redundant combiner

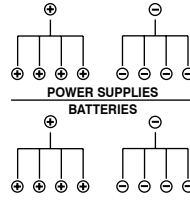
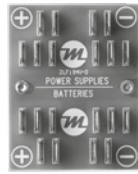
 OPERATIVITÀ - OPERATIVITY
 12V 15A - 24V 12A - 48V 8A MAX

RAIL BAR ACCESSORIES

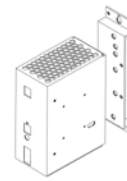
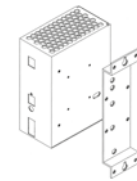
 Mod. **MF1**Euro **28,00**
 [cod. 1002403]

Basetta multi fast-on per parallelo
5 poli 4 vie - 15A max
Multi fast-on parallel 5 poles - 4 ways
15A max

 Montaggio sul retro
 Rear side mounting

 Montaggio laterale
 Lateral mounting

 Mod. **FL1**Euro **25,00**
 [cod. 1002404]

Flangia TOP-R/CRD
per montaggio a parete
TOP-R/CRD flange wall installation

CAP. 24

PACCHI BATTERIE MODULARI RICARICABILI

BARRA DIN - CASSETTO RACK 19"

 Batterie lunga vita 6-9 anni,
 pronti all'uso, parallelabili

BATTERY PACKS - SEALED LEAD ACID

RAIL BAR MOUNTING - 19" RACK PLUG-IN

 Long life batteries 6-9 years,
 ready to install, parallel facility

DIN BAR

Mod. BP 12/7	12V	7,5Ah	90W	[cod. 1006101].....Euro	120,00
Mod. BP 12/15	"	15Ah	180W	[cod. 1006103].....	" 200,00
Mod. BP 12/18	"	18Ah	220W	[cod. 1006104].....	" 230,00
Mod. BP 24/3	24V	3Ah	72W	[cod. 1006102].....	" 120,00
Mod. BP 24/7	"	7.5Ah	180W	[cod. 1006105].....	" 200,00
Mod. BP 24/9	"	9Ah	220W	[cod. 1006106].....	" 260,00

Collegabili in serie e parallelo - Series and parallel facility

RACK 19"

Mod. BPR 12/24	12V	24Ah	300W	[cod. 1006001].....Euro	390,00
Mod. BPR 12/48	"	48Ah	600W	[cod. 1006002].....	" 750,00
Mod. BPR 24/24	24V	24Ah	600W	[cod. 1006003].....	" 750,00
Mod. BPR 48/7	48V	7.5Ah	380W	[cod. 1006004].....	" 430,00
Mod. BPR 48/12	"	12Ah	600W	[cod. 1006005].....	" 750,00

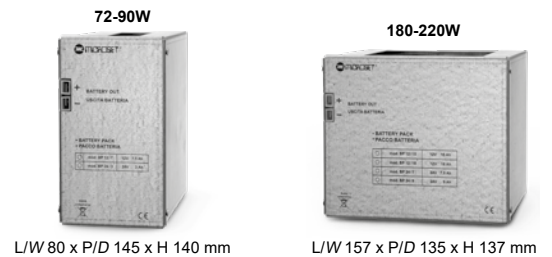
PARALLEL FACILITY

L/W 80 x P/D 145 x H 140 mm

L/W 157 x P/D 135 x H 137 mm



Rack 19" 3U x P/D 210 mm

CAP. 25

BATTERIE PIOMBO CALCIO ERMETICO

ALTA QUALITÀ - TECNOLOGIA AGM

Marca HITACHI / SKB-CSB

SEALED LEAD ACID BATTERIES

HIGH QUALITY - AGM TECHNOLOGY

HITACHI / SKB-CSB brand or similar

3-5 YEARS	Mod.	V	Ah	[cod.]	Euro	Size (mm)	Weight
	607	6V	7,2Ah	[cod. 2035306].....	20,00	w 151 - d 34 - h 97,5	1.4kg
	1203	12V	3-3,2Ah	[cod. 2035307].....	" 26,00	w 134 - d 67 - h 67	1.4kg
	1218	"	18Ah	[cod. 2035210].....	" 78,00	w 181 - d 76 - h 167	5.7kg
	1207	12V	7-7,5Ah	[cod. 2035274].....	" 37,00	w 151 - d 65 - h 97,5	2.2kg
	1209	"	9Ah	[cod. 2035355].....	" 45,00	w 151 - d 65 - h 97,5	2.7kg
	1212	"	12Ah	[cod. 2035373].....	" 72,00	w 151 - d 97,5 - h 97,5	4.2kg
	1226	"	26Ah	[cod. 2035353].....	" 180,00	w 166 - d 175 - h 125	7.6kg
	1209L	"	9Ah	[cod. 2035398].....	" 55,00	w 151 - d 65 - h 97,5	2.7kg
	1240	12V	40Ah	[cod. 2035137].....	" 205,00	w 197 - d 165 - h 170	13.0kg
	1265	"	65Ah	[cod. 2035140].....	" 290,00	w 355 - d 167 - h 183	20.2kg
	1280	"	80Ah	[cod. 2035350].....	" 360,00	w 355 - d 167 - h 183	22.0kg
	12100	"	100Ah	[cod. 2035367].....	" 390,00	w 330 - d 171 - h 222	30.0kg
	12120	"	120Ah	[cod. 2035358].....	" 525,00	w 330 - d 171 - h 222	32.0kg
	12150	"	150Ah	[cod. 2035389].....	" 560,00	w 485 - d 172 - h 246	40.0kg
	12200	"	200Ah	[cod. 2035366].....	" 720,00	w 522 - d 238 - h 223	65.0kg

QUALITY TEST
 ONE BY ONE

 Fornite sciolte, con test funzionale.
 Cablaggio su richiesta.

 Quality test one by one, wiring connection
 by request

CAP. 26

CONVERTITORI DI TENSIONE DA 24V A 13,5Vdc
 Switch mode alta efficienza - alta affidabilità

24V TO 13,5Vdc STEP DOWN CONVERTERS
 Switch mode high efficiency

Mod. CONTACT 10	Input 24Vdc (20-30V)	Output 13.5Vdc	10A-15A max	[cod. 1025019].....Euro	70,00
Mod. CONTACT 20	“ “	“ “	20A	[cod. 1025023].....	“ 120,00
Mod. CONTACT 40	“ “	“ “	40A	[cod. 1025022].....	“ 190,00

VERSIONI con TENSIONI INGRESSO ESTESA
WIDE INPUT RANGE VERSIONS

Mod. CONTACT 40.100.24	Input 80-120Vdc	Output 24Vdc	40A	[cod. 1025014].....Euro	365,00
Mod. CONTACT 30.48.12	“ 40-55Vdc	“ 13.5Vdc	30A	[cod. 1025018].....	“ 310,00

CAP. 27

CONVERTITORI DI TENSIONE DC-DC
 ISOLAMENTO GALVANICO INGRESSO-USCITA

DC-DC CONVERTERS
 IN-OUT GALVANIC INSULATION

 Regolazione d'uscita $\pm 15\%$
 Polarità flottanti
 Positivo o negativo a massa
 Parallelabili su specifica
 Montaggio a barra DIN
 Controllo remoto

 Adjustable output voltage $\pm 15\%$
 Floating polarity
 Positive or negative to ground
 Parallel facility on request
 Rail bar mounting
 Remote control

 Size **A** L/W 53 x
 P/D 106 x H 132 mm.

 Size **B** L/W 76 x
 P/D 145 x H 138 mm.

 Size **B1** L/W 94 x
 P/D 145 x H 138 mm.

 Size **C** L/W 85 x
 P/D 163 x H 138 mm.

Mod. CRD 12.12.15	Input 12Vdc	Output 13.5Vdc	(10\div17V)	12 - 15A	Size B1	[cod. 1025039].....Euro	215,00
Mod. CRD 12.19.12	“ (9-18V)	“ 19Vdc	“	10 - 12A	“ B1	[cod. 1025042].....	“ 215,00
Mod. CRD 12.24.12	“ “	“ 24Vdc	(23\div26V)	10 - 12A	“ B1	[cod. 1025037].....	“ 220,00
Mod. CRD 24.12.20	Input 24Vdc	Output 13.5Vdc	(10\div17V)	15 - 20A	Size B1	[cod. 1025033].....	“ 215,00
Mod. CRD 24.24.14	“ (20-30V)	“ 24Vdc	(23\div26V)	10 - 14A	“ B1	[cod. 1025036].....	“ 230,00
Mod. CRD 24.48	“ “	“ 48Vdc	(47\div56V)	7 - 9A	“ C	[cod. 1025032].....	“ 240,00
◦ Mod. CRD 48.12.4	Input 48Vdc	Output 13.5Vdc	(10\div15V)	2 - 4A	Size A	[cod. 1025040].....	“ 120,00
Mod. CRD 48.12.7	“ (40-60V)	“ “	(8\div16V)	5 - 7A	“ A	[cod. 1025028].....	“ 145,00
Mod. CRD 48.12.18	“ “	“ “	(10\div17V)	15 - 18A	“ B	[cod. 1025035].....	“ 230,00
◦ Mod. CRD 48.24.2	“ “	“ 24Vdc	(21\div28V)	1.5 - 2A	“ A	[cod. 1025041].....	“ 120,00
Mod. CRD 48.24.5	“ “	“ “	(21\div28V)	4 - 5A	“ A	[cod. 1025034].....	“ 155,00
Mod. CRD 48.24.12	“ “	“ “	(23\div31V)	10 - 12A	“ B	[cod. 1025030].....	“ 215,00
Mod. CRD 48.48	“ “	“ 48Vdc	(47\div56V)	8 - 10A	“ B1	[cod. 1025031].....	“ 230,00
new Mod. CRD 80.24.10	Input 68-85Vdc	Output 24Vdc	(23\div31V)	8 - 10A	“ B	[cod. 1025044].....	“ 250,00

◦ Remote control (Input failure), input range 40-100Vdc

Opzione:

 Cablaggio PARALLELO **2 convertitori**
3 convertitori
Optional:

 PARALLEL wiring **2 converters** [cod. 1002409].....Euro **95,00**
3 converters [cod. 1002410]..... “ **165,00**
DC2 Collegamento in ridondanza

DC2 Two ways power redundant [cod. 1002408]..... “ **95,00**
FL1 Flangia installazione muro

FL1 Flange wall installation [cod. 1002404]..... “ **25,00**

CAP. 28

RIDUTTORI DI TENSIONE DA 24V A 12 Vdc
 ALTA QUALITÀ E AFFIDABILITÀ

LINEAR 24V TO 12Vdc step-down CONVERTERS
 TOP QUALITY AND RELIABILITY

Mod. RT15	Input 24V (20-30V)	Output 13.5Vdc	15 - 20A max	[cod. 1025004].....Euro	100,00
Mod. RT30	“ “	“ “	25 - 30A max	[cod. 1025005].....	“ 160,00

Protezione al sovraccarico e sovratensione in uscita

Overload and overvoltage protection



CAP. 29

CARICA BATTERIE AUTOMATICO
AMPEROMETRO ANALOGICO INDICATORE DI CARICA
 Ricarica tutti i tipi di batteria
 Uso permanente in tampone o temporaneo

FULL AUTOMATIC BATTERY CHARGER
ANALOG AMMETER - CHARGE INDICATION
 Recharge all battery types
 Stationary or temporary use

Carica a fondo e leggera di mantenimento
 Prova efficienza batterie
 Doppie uscite: faston e pinze cocodrillo



Heavy and soft charge
 Battery efficiency test
 Double outlets: faston and crocodile clips

NOVITÀ! Installazione barra din

NEW! Din bar installation

Mod. POLAR 12.7	Uscita	12Vdc	7-10A max	Charging	1 batt. 12V 40-120Ah [cod. 1005020].....Euro	100,00
Mod. POLAR 24.4	Output	24Vdc	4 - 6A max	"	1 batt. 24V 20-65Ah [cod. 1005021].....	105,00
Mod. POLAR 48.3	"	48Vdc	2 - 3A max	"	1 batt. 48V 7-40Ah [cod. 1005023].....	110,00

Applicazioni: auto, moto, camper, trattori,
 imbarcazioni, camion, sicurezza

Applications: cars, trucks, boats, motorbike,
 campers, tractors, security

CAP. 30

CARICABATTERIA DA BARRA DIN
Senza strumento

DIN RAIL BAR BATTERY CHARGER
Without meter
 Single use or as additional battery charger for TOP-R BC/BCS
 power supplies, outlets in/out - without meter

Mod. TOP-R 108/B	Uscita	12Vdc	7-10A max	Charging	1 batt. 12V 40-120Ah [cod. 1002276].....Euro	100,00
Mod. TOP-R 205/B	Output	24Vdc	4 - 6A max	"	1 batt. 24V 20-65Ah [cod. 1002277].....	105,00
Mod. TOP-R 403/B	"	48Vdc	2 - 3A max	"	1 batt. 48V 7-40Ah [cod. 1002278].....	110,00

CAP. 31

CARICA BATTERIE AUTOMATICI
A TRE USCITE INDIPENDENTI

AUTOMATIC BATTERY CHARGERS
THREE INDEPENDENT BATTERIES
 Recharge all battery types:
 AGM, gel, sealed lead acid
 Stationary or temporary use

Ricarica tutti i tipi di batteria:
 AGM, gel, piombo
 Uso permanente in tampone o temporaneo



BCS250

Applications:
 - Mobile homes with several batteries
 In use - boats - caravans - cars
 - Truck - fork lift - workshops
 - Solar panel application

Mod. BCS 130	Uscita	12Vdc	30A	Charging	3 Batt 40-100Ah or 1 Batt. 100-400Ah [cod. 1005013].....Euro	290,00
Mod. BCS 150	Output	"	50A	Capacity	3 Batt. 150-300Ah or 1 Batt. 300-600Ah [cod. 1005018].....	380,00
Mod. BCS 220B	"	24Vdc	25A	"	3 Batt. 24 - 70Ah or 1 Batt. 40-200Ah [cod. 1005014].....	300,00
Mod. BCS 250	"	"	50A	"	3 Batt. 150-300Ah or 1 Batt. 300-600Ah [cod. 1005017].....	390,00
Mod. BC 412	"	48Vdc	12A	"	Single out 1 Batt. 30-200Ah [cod. 1005022].....	320,00

CAP. 32

CARICABATTERIA SWITCHING IN RACK 19"
PER GRANDI PACCHI BATTERIE CON SCHEDA SYNCRO

SWITCHING BATTERY CHARGER 19" PLUG-IN
LARGE CAPACITY, SYNCRO BOARD INCLUDED
 Use stand-alone or as additional battery charger of HP-RM power
 supply

Uso singolo o come carica batterie supplementare
 ad Alimentatori HP-RM

- Protezione al cortocircuito accidentale
- Strumento di misura digitale
- Controllo microprocessore
- Remote control



2 UNITS RACK 19"

- Accidental short circuit protection
- Digital measuring instrument
- Microprocessor control
- Remote control

Mod. SP 150R-BC	Uscita	12Vdc	50A	Charging	1 Batt. 12V 400-600Ah [cod. 1005025].....Euro	650,00
Mod. SP 230R-BC	Out	24Vdc	30A	Capacity	1 Batt. 24V 300-400Ah [cod. 1005027].....	700,00
Mod. SP 420R-BC	"	48Vdc	20A	"	1 Batt. 48V 200-300Ah [cod. 1005026].....	750,00

CAP. 33

**SISTEMI DI CONTINUITA'
 DA ESTERNO IP55**
 INSTALLAZIONE A PALI STRADALI E PARETE

 USO VIDEOSORVEGLIANZA URBANA
 e SICUREZZA

SISTEMA NO BREAK

 Di notte ricarica/accumula
 Di giorno eroga energia

 Batterie professionali Hitachi
 CSB lunga vita

CABLATO PRONTO ALL'USO
RISPARMIO DI TEMPO E DENARO

L/W 540 x P/D 230 x H 650 mm

**DC UPS POWER SYSTEM
 IP55 OUTDOOR CABINET**
 STREET LAMP or WALL INSTALLATION

 USE: SURVEILLANCE CAMERA and
 SECURITY SYSTEMS

NO BREAK SYSTEM

 Recharge by night
 Energy supply during day

 Hitachi or CSB professional
 batteries long life

READY TO INSTALL
SAVE TIME AND MONEY

 Il **Comby Cab** è un pratico e sicuro sistema di alimentazione cablato. Dimensionato per "ciclo lampione": di notte in presenza rete ricarica le batterie e alimenta il carico, di giorno eroga energia continuata dalle batterie con autonomia fino a 18h.

Comby Cab is a practical and safe D.C. power supply system. "Street lighting cycle": by night with line on recharge the batteries and supply the user loads, during daylight hours, the loads are supplied by batteries up to 18 hours autonomy.
Dotazioni - protezioni:

- Ingresso rete con interruttore magnetotermico bipolare
- Sezionatore batteria con fusibile di protezione
- Protezione contro i fulmini
- Ventilazione forzata
- Stacco batteria scarica con ripristino
- Rete di protezione anti insetto
- Rapida installazione batterie

**REMOTE CONTROL
 (contatti secchi 60V 1Amax):**

- Batteria esausta
- Batteria carica-scarica
- Rete PRESENTE-ASSENTE

CONTROLLI SNMP:

- Stati operativi (rete ON/OFF, carico V/A, livello batteria)
- Temperatura di esercizio
- Spegnimento/accensione
- Test batterie

Features - protections:

- Input line breaker
- Battery protection fuse
- Lightning protection transformer
- Cooling fan
- Low battery shutdown with automatic restart
- High security triple insulation
- Easy rapid installation

**REMOTE CONTROL
 (dry contacts 60V 1A):**

- Full-low battery
- Battery failure
- Line ON - OFF

SNMP MONITORING:

- Operative status: line ON/OFF, load V/A, battery level
- Temperature
- Load turn ON/OFF
- Battery test

Mod.	COMBY CAB 12-100	Uscita	12Vdc 16A	Charger	13A	Battery	12V 100Ah	Autonomy	18h load	5AEuro	1.520,00
Mod.	COMBY CAB 24-50 [cod. 10160110]	Out	24Vdc 10A	"	7A	"	24V 50Ah	"	"	3A	1.540,00
Mod.	COMBY CAB 48-25 [cod. 10160103]	"	48Vdc 6A	"	4A	"	48V 25Ah	"	"	1A	1.600,00
Mod.	COMBY CAB SNMP 12-100 [cod. 10160130]	"	12Vdc 16A	"	7-8A	Battery	12V 100Ah	Autonomy	18h load	5AEuro	1.820,00
Mod.	COMBY CAB SNMP 24-50 [cod. 10160131]	"	24Vdc 10A	"	5-6A	"	24V 50Ah	"	"	3A	1.850,00
Mod.	COMBY CAB SNMP 48-25 [cod. 10160127]	"	48Vdc 6A	"	3-4A	"	48V 25Ah	"	"	1A	1.900,00

COMPOSIZIONE:

- Alimentatore TOP-R
- Controllore caricabatteria automatico: **COMBY** (Comby Cab) **SNMP** (Comby Cab SNMP)
- Trasformatore di isolamento 400VA
- Pacco batterie 1200W 4x 12V 26Ah (Hitachi - CSB)
- Cabinet acciaio INOX verniciato a tenuta d'acqua IP55

DELIVERY PARTS:

- Power supply TOP-R
- Automatic battery charger controller: **COMBY** (Comby Cab) **SNMP** (Comby Cab SNMP)
- Input insulation trafo 400VA
- Battery pack 1200W 4x 12V 26Ah (Hitachi - CSB)
- INOX steel cabinet painted waterproof IP55

Opzioni:

- **STAFFA TIPO 1:**
installazione palo Ø 40÷70 mm e parete
- **STAFFA TIPO 2:**
installazione palo Ø 114÷200 mm
- **COIBENTAZIONE INTERNA** per alte e basse temperature
- **TRATTAMENTO MARINO** cabinet e tropicalizzazione schede elettroniche
- DC-DC stabilizzatore di tensione d'uscita vd. **cap. 27**

Optional:

- **CLAMPS TYPE 1:**
mast Ø 40÷70 mm and wall installation [cod. 10160104].....Euro **110,00**
- **CLAMPS TYPE 2:**
mast installation Ø 114÷200 mm [cod. 10160119]..... " **150,00**
- **THERMAL INSULATION** for high and low temperature..... " **100,00**
- **MARINE TREATMENT CABINET** and electronic boards tropicalization " **300,00**
- Output DC-DC converter see **cap. 27**

CAP. 34

SISTEMI DI CONTINUITA' DA INTERNO ED ESTERNO IP55
 INSTALLAZIONE A PARETE E A PALO

Uso videosorveglianza, sistemi di sicurezza e antincendio

Batterie professionali Hitachi CSB lunga vita

CABLATO PRONTO ALL'USO



L/W 400 x P/D 207 x H 471 mm

DC UPS POWER SYSTEM INDOOR AND OUTDOOR CABINET IP55
 STREET MAST or WALL INSTALLATION

Safety and security application, CCTV and fire prevention systems

Hitachi or CSB long life professional batteries

READY TO INSTALL

 Il **Comby Cab Mini** è un pratico e sicuro sistema di alimentazione di continuità cablato con batterie di backup, in nuovo cabinet di dimensioni compatte, con disponibilità di spazio per installare moduli di rete. Porta apribile dx/sx con chiave, possibilità di coibentazione, ventola sempre attiva.

COMPOSIZIONE:

- Alimentatore caricabatterie **TOP-R BCS**
- Trasformatore di isolamento **340VA**
- Pacco batterie 400W (n° 4 batt. 12V 9Ah long life)
- Cabinet in acciaio **INOX verniciato** a tenuta d'acqua **IP55**

 The new **Comby Cab Mini** is a practical and safe D.C. uninterruptible power supply system, pre-wired, with batteries, in a water proof cabinet compact size in **INOX stainless steel**, with space for network modules. Door opening double side with key, thermal insulation facility, fan always operative.

ON BOARD HARDWARE:

- Power supply battery charger **TOP-R BCS**
- Input insulation trafo **340VA**
- Battery pack 400W (n° 4 batt. 12V 9Ah long life)
- **INOX painted steel waterproof IP55 cabinet**

Mod. COMBY CAB MINI 12-36 [cod. 10160132]	Uscita	12Vdc 15A	Charger	3A	Battery	12V 36Ah	Autonomy	3h load 9AEuro	950,00
Mod. COMBY CAB MINI 24-18 [cod. 10160133]	Out	24Vdc 10A	"	2A	"	24V 18Ah	"	"	"	960,00
Mod. COMBY CAB MINI 48-9 [cod. 10160115]	"	48Vdc 6A	"	1A	"	48V 9Ah	"	"	"	970,00

Opzioni: vd. pag. 12

Optional: see page 12

CAP. 35

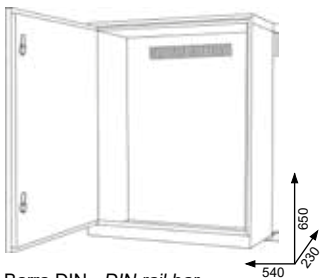
CABINET PER ESTERNO IP55
 IN ACCIAIO INOX VERNICIATO

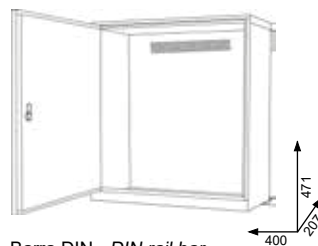
 Barra DIN - DIN rail bar
 Able to contain up to: 6 monoblocks 12V 26Ah

CAB IP55.....Euro 580,00

 Barra DIN - DIN rail bar
 Able to contain up to: 4 monoblocks 12V 7/9/12Ah

CAB MINI IP55.....Euro 450,00
OUTDOOR CABINET IP55
 PAINTED INOX STEEL

Opzioni - Optionals:

- **STAFFE DA PALO E PARETE MAST AND WALL CLAMPS**
[cod. 10160104]
TYPE 1: Ø 40÷70 mm.....Euro **110,00**
- **STAFFE DA PALO - MAST CLAMPS**
[cod. 10160119]
TYPE 2: Ø 114÷200 mm.....Euro **150,00**
- **COIBENTAZIONE.....Euro 100,00**
THERMAL INSULATION

CAP. 36

ARMADI RACK 19" CON VASSOI BATTERIE
 ROBUSTI - FUNZIONALI - CARICO FINO A 250 Kg
 3 lati removibili, forniti assemblati, frontale chiuso con grata aerazione 3U

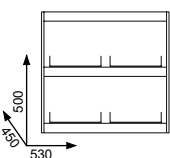
RACK 19" CABINET WITH BATTERY HOLDERS
 STRONG STRUCTURE - LOAD 250 Kg max
 3 removable panels, front panel with 3U grate delivered assembled

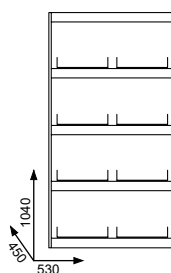
 Completo di vassoi Battery holder
 Può contenere - Able to:
 8 monoblocks 12V 24-40Ah
 4 monoblocks 12V 65-80Ah

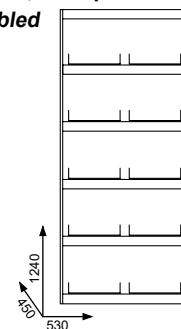
RACK 9 UNITS...Euro 430,00

 Completo di vassoi Battery holder
 Può contenere - Able to:
 16 monoblocks 12V 24-40Ah
 9 monoblocks 12V 65-80Ah

RACK 19 UNITS...Euro 525,00

 Completo di vassoi Battery holder
 Può contenere - Able to:
 20 monoblocks 12V 24-40Ah
 8 monoblocks 12V 120Ah

RACK 24 UNITS...Euro 590,00

NOVITÀ PRODOTTO - PRODUCT NEWS

SOLAR GENERATORS

Generatori fotovoltaici stand-alone con sistema di accumulo per generare corrente continua dal sole, utilizzabile per alimentare apparati elettronici, sistemi di videosorveglianza, sistemi di sicurezza ecc. in zone prive di distribuzione di energia elettrica.

Stand-alone solar panel systems with storage battery able to generate DC "green" power from the sun. Usable for supplying electronic equipments, CCTV, safety equipments in peripheral areas without any electric network service.

CAP. 37

GENERATORE FOTOVOLTAICO CON ACCUMULO

PANNELLO SOLARE CILINDRICO DA PALO

Parti cablate in CABINET da ESTERNO IP55



SOLAR GENERATOR WITH STORAGE BATTERY

CYLINDRIC SOLAR PANEL, POLE MOUNTING

Wired parts in OUTDOOR CABINET IP55

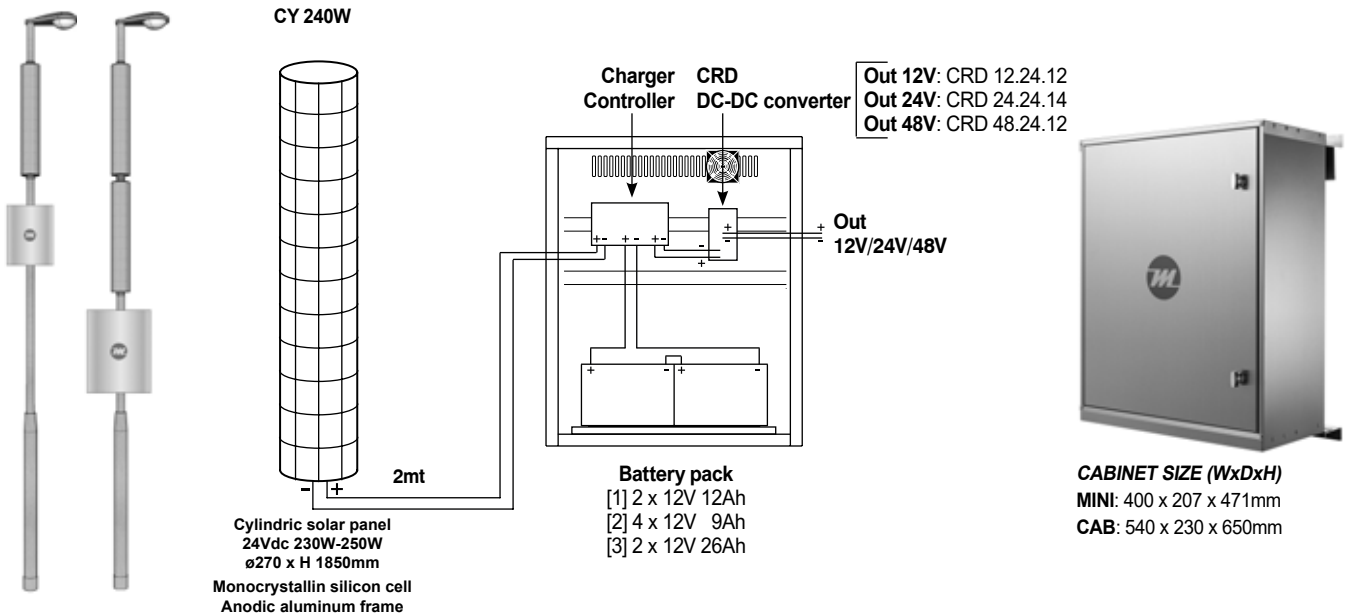

Composizione:

- 1 pannello fotovoltaico CY 240W
- Pacco batterie [1] / [2] / [3]
- 1 DC-DC converter uscita 12V/24V/48V
- 1 cablaggio di connessione L=1,5mt
- Regolatore di carica 10A
- Cabinet IP55: Mini Cab (400x207x471mm)
Cab (540x230x650mm)

Delivered Parts:

- 1 CY solar panel 240W
- Battery pack [1] / [2] / [3]
- 1 DC-DC converter out 12V/24V/48V
- 1 connection wiring L=1,5mt
- Solar battery regulator 10A
- Cabinet IP55: Mini Cab (400x207x471mm)
Cab 540x230x650mm

Mod. CY-CAB 12/12V	1 CY panel, Batt. 2 x 12V 12Ah, Cabinet MINI , Autonomy 12h (24W),	Out 12-24V.....Euro	1.850,00
Mod. CY-CAB 12/24V	" " " " " "	Out 24V.....Euro	1.850,00
Mod. CY-CAB 12/48V	" " " " " "	Out 48-24V.....Euro	1.850,00
Mod. CY2-CAB 18/12V	2 CY panels, Batt. 4 x 12V 9Ah, Cabinet MINI , Autonomy 18h (24W),	Out 12-24V.....Euro	2.650,00
Mod. CY2-CAB 18/24V	" " " " " "	Out 24V.....Euro	2.650,00
Mod. CY2-CAB 18/48V	" " " " " "	Out 24-48V.....Euro	2.650,00
Mod. CY2-CAB 26/12V	2 CY panels, Batt. 2 x 12V 26Ah, Cabinet CAB , Autonomy 26h (24W),	Out 12-24V.....Euro	2.800,00
Mod. CY2-CAB 26/24V	" " " " " "	Out 24V.....Euro	2.800,00
Mod. CY2-CAB 26/48V	" " " " " "	Out 24-48V.....Euro	2.800,00
Mod. CY240	Cylindric solar panel 240W ø270 x H 1850mm.....Euro		850,00

NOVITÀ PRODOTTO - PRODUCT NEWS

SOLAR GENERATORS

VERSIONI FORNITE IN PARTE STACCATE PANNELLO SOLARE "STANDARD"

Composizione:

- 1 pannello fotovoltaico 230-250W
- Pacco batterie 24V 12Ah (2 batterie 12V 12Ah)
- 1 DC-DC converter da:
 - 24Vdc → 12Vdc CRD 24.12.15
 - 24Vdc → 24Vdc CRD 24.24.14
 - 24Vdc → 48Vdc CRD 24.48
- 1 cablaggio di connessione
- Regolatore di carica 10A
- **KIT DI FISSAGGIO PANNELLO**
per ancoraggio a supporti da campo o testapalo (non forniti)

SINGLE PARTS DELIVERED VERSIONS CLASSIC SOLAR PANEL

Delivery parts:

- 1 solar panel 230-250W
- Battery pack 24V 12Ah (2 batteries 12V 12Ah)
- 1 DC-DC converter:
 - 24Vdc → 12Vdc CRD 24.12.15
 - 24Vdc → 24Vdc CRD 24.24.14
 - 24Vdc → 48Vdc CRD 24.48
- 1 connection wiring
- Solar battery regulator 10A
- **PANEL FIXING KIT**
for anchoring to field supports or pole tops (not delivered)

Mod. PF 12	Uscita	24 - 12Vdc	con/with CRD 24.12.15Euro	1.480,00
Mod. PF 24	Output	24 - 24Vdc	con/with CRD 24.24.14"	1.500,00
Mod. PF 48	"	24 - 48Vdc	con/with CRD 24.48"	1.520,00

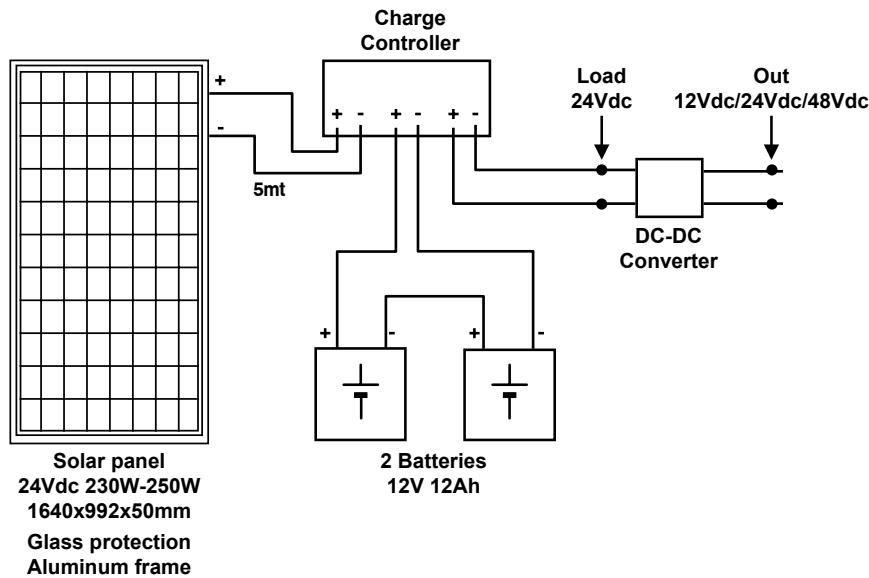

Opzioni:

- **CABINET IP55 CAB MINI** 400x207x471mm
per alloggiamento parti
- **STAFFE DA PALO Ø114÷ 200mm**
- **PANNELLO SOLARE 240W** 1640x992x50mm

Optional:

- **CABINET IP55 CAB MINI** 400x207x471mm.....Euro **450,00**
for hardware housin
- **CLAMPS FOR POLE INSTALLATION Ø114÷ 200mm**.....Euro **120,00**
- **SOLAR PANEL 240W 97xH 1500mm**.....Euro **580,00**

CAP. 38

INVERTER AD ONDA SINUSOIDALE PURA
 INGRESSO 12-24Vdc - USCITA 230Vac

PURE SINE WAVE INVERTERS
 INPUT 12-24Vdc - OUTPUT 230Vac

Mod. SP 300-12	Input 12Vdc	Potenza 300VA	[cod. 1016117].....	Euro 275,00
Mod. SP 300-24	" 24Vdc	<i>Out Power</i> 300VA	[cod. 1016120].....	" 275,00
Mod. SP 600-12	" 12Vdc	" 600VA	[cod. 1016099].....	" 350,00
Mod. SP 600-24	" 24Vdc	" 600VA	[cod. 1016100].....	" 350,00
Mod. SP 1000-12	" 12Vdc	" 1000VA	[cod. 1016101].....	" 540,00
Mod. SP 1000-24	" 24Vdc	" 1000VA	[cod. 1016102].....	" 540,00
Mod. SP 1500-12	" 12Vdc	" 1500VA	[cod. 1016103].....	" 759,00
Mod. SP 1500-24	" 24Vdc	" 1500VA	[cod. 1016104].....	" 759,00
Mod. SP 2000-12	" 12Vdc	" 2000VA	[cod. 1016105].....	" 946,00
Mod. SP 2000-24	" 24Vdc	" 2000VA	[cod. 1016106].....	" 946,00
Mod. SP 3000-24	" 24Vdc	" 3000VA	[cod. 1016109].....	" 1.045,00



FRONT



REAR

 Adatti per alimentare strumenti di misura, computer, apparati elettronici sofisticati. **Alta stabilità di tensione, bassa distorsione.**
 Sistema di avvio soft-start. EMI test.

 Suitable to power sophisticated instruments, PC, electronic apparatus etc. **High stability, low distortion.**
 Soft start system. EMI test

Su richiesta versioni ONDA A GRADINI PS 1000 12/24

On request, STEP WAVE versions PS 1000 12/24

CAP. 39

INVERTER CON SINUSOIDE PURA
 INGRESSO -48Vdc → USCITA 230Vac
 CONTROLLO ATTIVO DEL CARICO
 ALTA EFFICIENZA E AFFIDABILITÀ
 Per telecom e pannelli solari

PURE SINE WAVE INVERTERS
 INPUT -48Vdc → OUT 230Vac
 POWER CONTROL SYSTEM
 HIGH EFFICIENCY AND RELIABILITY
 Telecom and solar application

Made in Italy

 RELIABLE
 NEW VERSIONS

- Alta stabilità di frequenza e tensione
- Controllo remoto di avaria inverter e batteria
- Protezione al sovraccarico.



New 2-3 UNITS 19" - P/D 250 mm

- Frequency and voltage high stability
- Remote control for inverter and battery failure
- Overload protection

Mod. SX 400R	Input 48Vdc	Potenza 400-600VA	2U-19" [cod. 1016110].....	Euro 450,00
Mod. SX 800R	" "	<i>Out Power</i> 800-1.2kVA	3U-19" [cod. 1016046].....	" 710,00
Mod. SX 1500R	" "	" 1.4k-1.6kVA	3U-19" [cod. 10160105].....	" 995,00

CAP. 40

GRUPPO DI CONTINUITÀ LINE INTERACTIVE
 Forma d'onda sinusoidale pura
 ISOLAMENTO GALVANICO IN USCITA
 Lunga vita operativa oltre 10 anni

EMERGENCY U.P.S. LINE INTERACTIVE
 Pure sinewave form
 OUTPUT GALVANIC SEPARATION
 Long life 10 years

Made in Italy

Mod. SX 120	Nominal Power 2kVA	- Inverter 1.2kVA	Autonomy 8-12 min	Euro 590,00
--------------------	---------------------------	--------------------------	--------------------------------	--------------------

[cod. 1016038]

 Rete 230V ± 10%, Uscita 230V ± 1% 50Hz
 Senza ventilatore, super silenzioso

 In 230V ± 10%, Out 230V ± 1% 50Hz
 Blower less, very silent operating

CAP. 41

GRUPPI DI CONTINUITÀ ON-OFF LINE
 STEP-WAVE - PER POSTAZIONE PC SINGOLO

ON-OFF LINE U.P.S.
 STEP WAVEFORM - HOME PC

- Dotazioni:**
- Display LCD
 - Stabilizzatore AVR
 - Protezione internet
 - Software di spegnimento automatico

- Features:**
- LCD display
 - AVR voltage stabilizer
 - Internet protection
 - Automatic software shutdown

Mod. 700 D	Potenza - Power 700VA	Autonomia - Autonomy 4-6 min	Euro 165,00
-------------------	------------------------------	---	--------------------

[cod. 1016085]



CAP. 42

SOCCORRITORI DI EMERGENZA
Forma d'onda a gradini
FORNISCONO SEMPRE 230 VAC IN USCITA
Funzionamento automatico

- Soft start di avvio
- Test efficienza batteria
- Installazione a parete
- Autonomia espandibile con pacchi batteria modulari
- Batterie lunga vita 7-10 anni

APPLICAZIONI TIPICHE:

- Pompe anti allagamento
- Apriporte e apricancelli elettrici
- Sistemi di allarme
- Distributori automatici



Made in Italy

EMERGENCY POWER UNITS
Modified waveform emergency
ALWAYS OPERATIVE OUTPUT 230VAC
Full automatic operating

- Soft start system
- Battery efficiency test
- Wall installation
- Autonomy extension by modular battery pack
- Long life batteries 7-10 years

TYPICAL APPLICATIONS:

- Anti-flood pumps
- Automatic gate and door openers
- Alarm systems
- Vending machines

Mod. SZ 60	Potenza 600VA	Autonomia 10-15 min.	carico 500VA	(E)	[cod. 10160101].....Euro	600,00
Mod. SZ 150	Power 1.5kVA	Autonomy 6-8 min.	load 700VA	(E)	[cod. 10160100]..... "	850,00
Mod. SZ 250	" 2.5kVA	" 5-10 min.	" 1.5kVA with Box A2		[cod. 1016119]..... "	1.500,00

(E) Batterie entrocontenute - Inside batteries

BATTERIE PER ESPANSIONE AUTONOMIA

Mod. SB 60	Autonomia 60min.	Batterie 4x 12V 7,5Ah (24V 15Ah)	Box A1	[cod. 1016061].....Euro	400,00
Mod. SB 150	Autonomy 60min.	Batteries 8x 12V 7,5Ah (24V 30Ah)	Box A2	[cod. 10160102]..... "	650,00

Possibilità di più pacchi batteria implementabili

ADDITIONAL BATTERY PACK

Supplementary battery packs facility

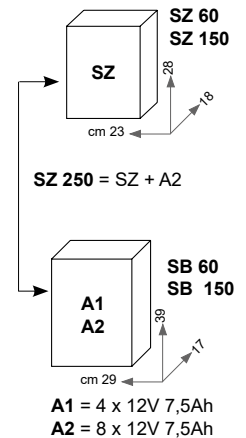

CAP. 43

GRUPPI DI CONTINUITÀ SOCCORRITORI LINE INTERACTIVE
Forma d'onda sinusoidale pura
ALTE PRESTAZIONI, TOTALMENTE AUTOMATICI

Sistema di stabilizzazione AVR,
 Batterie lunga vita
 Stacco automatico limite di carica
 Interfaccia e software di controllo
 Silenzioso – ventilatore operativo solo in emergenza



EMERGENCY U.P.S. LINE INTERACTIVE
Pure sine waveform
HIGH PERFORMANCE, FULL AUTOMATIC

AVR voltage stabilizer,
 Long Life Batteries
 Automatic shutdown
 Interface and control software
 Low noise – blower only on emergency

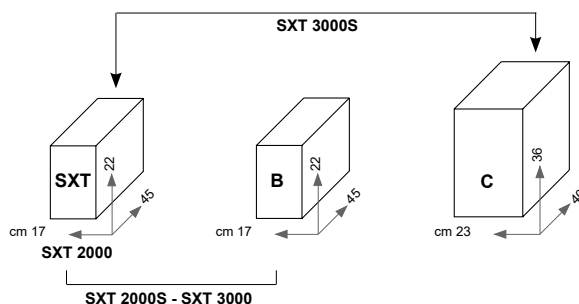

Mod. SXT 2000	Potenza 2kVA	Autonomia 10 min	carico 600VA	(E)	[cod. 1016092].....Euro	950,00
Mod. SXT 2000S	Power 2kVA	Autonomy 60 min.	load 600VA	Box B	[cod. 10160136]..... "	1.450,00
Mod. SXT 3000	" 3kVA	" 8 min.	" 2kVA	Box B	[cod. 1016094]..... "	1.520,00
Mod. SXT 3000S	" 3kVA	" 20-30 min.	" 2kVA	" C	[cod. 10160112]..... "	1.900,00

BATTERIE
SXT 2000 : (E) entrocontenute inside batteries
 4 x 12V (48V) 7,5Ah

SXT 2000S : (E) + Box B
 4+8 x 12V (48V) 7,5Ah

BATTERIES
SXT 3000 : Box B
 8 x 12V (48V) 7,5Ah

SXT 3000S : Box C
 12 x 12V (48V) 9Ah

CAP. 44

GRUPPI DI CONTINUITÀ ON-LINE
NO BREAK DOPPIA CONVERSIONE
Forma d'onda sinusoidale pura
INGRESSO-USCITA MONOFASE
230V 50-60Hz

OPERATIVI CONTRO LE
MICRO E PROLUNGATE
INTERRUZIONI

Applicazioni:

- Computer e server
- Reti informatiche
- Automazione
- Sistemi di emergenza
- Telefonia
- Casse automatiche

Dotazioni:

Controllo a microprocessore
 PFC sistema risparmio energetico
 Stabilizzano e filtrano la rete
 EPO - disattivazione rapida
 Interfaccia USB e RS232
 Software di monitoraggio incluso
 Ventilazione forzata



ON-LINE DOUBLE CONVERSION
NO BREAK U.P.S.
Pure sine waveform
INPUT-OUTPUT MONOPHASE
230V 50-60Hz

VERY EFFICIENT AGAINST
MICRO AND LONG
POWER INTERRUPTIONS

Applicazioni:

- Pc server
- Networking
- Automation
- Emergency systems
- Telecom
- Automatic cashiers



PMT30

PMT10

NUOVI MODELLI PLUS
AUTONOMIA ESTESA
BATTERIE LUNGA VITA

NEW PLUS MODELS
EXTRA AUTONOMY CABINET
LONG LIFE BATTERIES

Features:

Microprocessor control
 Power Factor Control - green mode
 Electronic voltage stabilizer
 and noise filter
 EPO emergency turn-off
 USB and RS232 interface
 Monitoring software included
 Cooling fan

Mod.	Potenza Power	Autonomia Autonomy	Batteries 12V N° Ah	UPS (mm) L-W P-D H	Battery Box (mm) L-W P-D H	Peso (kg) Weight	Product Code	Prezzo Price
PMT 10	1kVA	6-10'	3 7,5	150x420x240	-	18	1016086	Euro 735,00
PMT 10 PLUS	1kVA	30-40'	3 + 6 7,5	"	155x410x240	38	10160122	" 1.450,00
PMT 15	1,5kVA	5-8'	3 7,5	150x420x240	-	19	1016084	" 820,00
PMT 15 PLUS	1,5kVA	30'	3 + 6 7,5 + 9	"	155x410x240	45	10160123	" 1.600,00
PMT 20	2kVA	6-12'	6 7,5	225x425x360	-	34	1016062	" 1.155,00
PMT 20 PLUS	2kVA	30'	6 + 12 7,5	"	230x400x360	78	10160124	" 2.200,00
PMT 30	3kVA	5-10'	6 7,5	225x425x360	-	36	1016090	" 1.430,00
PMT 30 PLUS	3kVA	30'	6 + 12 7,5 + 9	"	230x400x360	85	10160121	" 2.520,00
PMT 60	6kVA	7-10'	20 7,5	260x590x580	-	106	1016087	" 3.180,00
PMT 60 PLUS	6kVA	40-60'	20 + 40 7,5	"	260x580x600	190	10160137	" 5.600,00
PMT 80	8kVA	5-10'	20 7,5	260x690x715	-	130	1016112	" 4.690,00
PMT 80 PLUS	8kVA	30'	20 + 40 7,5	"	260x580x600	220	10160138	" 7.150,00
PMT 100	10kVA	5-10'	20 9	260x690x715	-	139	1016111	" 5.200,00
PMT 100 PLUS	10kVA	30'	20 + 40 9	"	260x580x600	240	10160139	" 7.990,00

Opzioni:

- modulo SNMP di rete
- Scheda contatti secchi su relè (AS400)

Optional:

- SNMP network module [cod. 10160128].....Euro **260,00**
- Dry relays contacts board (AS400) [cod. 10160140].....Euro **80,00**

GRUPPI DI CONTINUITÀ SOCCORRITORE
A NORMA EN 50171
INPUT/OUTPUT 230Vac MONOFASE

- Batterie long life 10 anni autoestinguenti (18 monoblocchi 12V 9Ah)
- Scheda contatti secchi su relè

UPS EMERGENCY UNIT
UNDER RULE EN50171
INPUT/OUTPUT 230Vac 1PH

- Long life 10 years batteriea self-extinguishing (18 monoblocks 12V 9Ah)
- Dry relay contact board included

Mod. **PMT 20 PLUS-S** Potenza – Power **2kVA** Autonomia – Autonomy **3h on 500W load** [cod. 10160141].....Euro **2.990,00**
1h on 1500W load

CAP. 45

**GRUPPI DI CONTINUITÀ IN RACK 19"
 ON LINE DOPPIA CONVERSIONE
 Forma d'onda sinusoidale pura**
**NO-BREAK SENZA INTERRUZIONE
 PFC RISPARMIO ENERGETICO
 AUTONOMIA ESPANDIBILE**
**Applicazioni:
 Networking, Server, Telecomunicazioni**
**RACK 19" PLUG-IN U.P.S.
 ON LINE DOUBLE CONVERSION
 Pure sine waveform**
**NO-BREAK WITHOUT ANY INTERRUPTION
 POWER FACTOR CONTROL
 EXPANDABLE AUTONOMY**
**Applications:
 Networking, Server, Telecom**

RACK - TOWER CONVERTIBLE

RACK + BATTERY PACK

RACK - TOWER CONFIGURATION
Dotazioni:

 Nuovo controllo a microprocessore
 PFC = 1 alta efficienza
 Funzionamento Energy Saving
 Stabilizzano e filtrano la rete
 Bypass interno automatico e manuale
 Display LCD a rotazione automatica
 Interfaccia RS232 e USB
 Software di monitoraggio incluso

Features:

 New microprocessor control
 PFC = 1 high efficiency
 Energy Saving Mode
 Line stabilization and filtering
 Internal bypass, automatic and manual
 LCD Display autorotation
 RS232 and USB interface
 Monitoring software included

Mod.	Potenza Power	Autonomia Autonomy	Batteries 12V		UPS (mm) L-W H P-D	Peso (kg) Weight	Product Code	Prezzo Price	
			N°	Ah					
PMR-RT 10	1kVA	5'	3	7,5	19" Rack 2U x 425 84 x 428 x 425 (tower)	18	1016126	Euro	800,00
PMR-RT 20	2kVA	5'	6	7,5	19" Rack 2U x 635 84 x 428 x 635 (tower)	30	1016122	"	1.300,00
PMR-RT 30	3kVA	5'	6	7,5	19" Rack 2U x 635 84 x 428 x 635 (tower)	35	1016127	"	1.650,00
PMR-RT 60	6kVA	9'	20	5	19" Rack 4U(2U+2U) x 635 2 x 84 x 428 x 635 (tower)	60	1016125	"	3.600,00

Opzioni:

- modulo SNMP di rete
- Scheda contatti secchi su relè (AS400)
- CASSETTI BATTERIE DI ESPANSIONE 3U:
BPR 72/7 72V (6 x 12V) 7,5Ah [cod. 1006008].....Euro **590,00**

Optional:

- **SNMP network module**.....Euro **260,00**
- **Dry relays contacts board (AS400)**.....Euro **80,00**
- **EXTRA BATTERY CABINET 3U:**
BPR 72/9 72V (6 x 12V) 9Ah [cod. 1006006]....Euro **650,00**

CAP. 46

**GRUPPO DI CONTINUITÀ IN RACK 19"
 FORMA D'ONDA A GRADINI**
**U.P.S. RACK 19" PLUG-IN
 STEP WAVEFORM**
Dotazioni:

 Test batterie
 Prese di ingresso e uscita
 sul frontale
 Segnalazioni LED: rete ON-OFF e anomalie

Rack 19" 2U x 320mm

Features:

 Battery test
 In-out plug on front panel
 LED signalling: ON-OFF line and failure

 Mod. **STEP 600R** Potenza - Power **600VA** Autonomy **5-7 min.** [cod. 1016097].....Euro **315,00**

CAP. 47

**GRUPPI DI CONTINUITÀ TRIFASE
ON LINE DOPPIA CONVERSIONE**
Forma d'onda sinusoidale pura
INGRESSO 3F 380-400Vac + N
USCITA 3F 380-400Vac / 1F 230Vac

 Operativi contro le micro e prolungate
 interruzioni

NO BREAK - Servizio continuo h24
VITA MEDIA 15 ANNI
Dotazioni:

PFC Risparmio Energetico

Sezionatori di rete, EPO

By-pass statico e manuale

Interfaccia RS232 opz. SNMP di rete

Configurabili a soccorritore EN50171
APPLICAZIONI:

- Macchine controllo numerico
- Processori industriali
- Reti informatiche e telefoniche
- Sistemi di emergenza - sicurezza

**INGRESSO TRIFASE 380-400Vac + Neutro
USCITA MONOFASE 230Vac**

10-30kVA

**3-PHASE PROFESSIONAL U.P.S.
ON LINE DOUBLE CONVERSION**
Pure sine waveform
INPUT 3PH 380-400Vac + N
OUTPUT 3PH 380-400Vac / 1PH 230Vac

 Very efficient against micro and long
 power interruptions

NO BREAK - Continuous service H24
LONG OPERATIVE LIFE 15 YEARS
Features:

PFC Energy Saving

Breakers, EPO

Static and manual by-pass

RS232 interface, SNMP optional

Emergency facility EN50171
APPLICATIONS:

- Machinery CNC system
- Industrial automation
- Computer and telephone networks
- Safety and security systems

**INPUT 3-phases 380-400Vac + Neutral
OUTPUT MONOPhase 230Vac**

Mod.	Potenza Power	Autonomy min	Batteries N° Ah	UPS Box cm L-W P-D H	Battery Box cm L-W P-D H	Peso Weight	Product Code	Prezzo Price
MTM 10/20	10kVA	27'	60 7,5	"	"	200	1016129	" 8.160,00
MTM 10/35	10kVA	35'	60 9	"	"	200	1016130	" 8.880,00
MTM 10/60	10kVA	65'	180 7,5	39x90x90	39x90x90	500	1016131	" 11.900,00
MTM 15/10	15kVA	10'	60 7,5	"	"	200	1016132	" 8.280,00
MTM 15/20	15kVA	20'	60 9	"	"	200	1016133	" 9.000,00
MTM 20/10	20kVA	10'	60 7,5	"	"	200	1016134	" 9.360,00
MTM 20/15	20kVA	15'	60 9	"	"	200	1016135	" 9.840,00
MTM 30/10	30kVA	8'	60 9	"	"	200	1016136	" 10.200,00
MTM 30/18	30kVA	18'	120 9	39x90x90	39x90x90	450	1016137	" 13.200,00
MTM 30/30	30kVA	36'	180 9	39x90x90	39x90x90	600	1016138	" 15.000,00

**INGRESSO TRIFASE 380-400Vac + Neutro
USCITA TRIFASE 400Vac + Neutro**

**INPUT 3-phases 380-400Vac + Neutral
OUTPUT 3-phases 400Vac + Neutral**

Mod.	Potenza Power	Autonomy min	Batteries N° Ah	UPS Box cm L-W P-D H	Battery Box cm L-W P-D H	Peso Weight	Product Code	Prezzo Price
MTT 10/20	10kVA	27'	60 7,5	39x90x90	"	200	1016139	Euro 8.280,00
MTT 10/35	10kVA	35'	60 9	"	"	230	1016140	" 8.880,00
MTT 10/60	10kVA	65'	180 7,5	39x90x90	39x90x90	500	1016141	" 12.000,00
MTT 20/10	20kVA	10'	60 7,5	"	"	200	1016142	" 9.360,00
MTT 20/15	20kVA	15'	60 9	39x90x90	"	250	1016143	" 9.960,00
MTT 30/10	30kVA	8'	60 9	"	"	230	1016144	" 10.320,00
MTT 30/15	30kVA	15'	120 7,5	39x90x90	39x90x90	450	1016145	" 12.600,00
MTT 30/30	30kVA	28'	180 9	"	"	600	1016146	" 15.000,00
MTT 40/10	40kVA	10'	120 7,5	"	"	450	1016128	" 15.600,00
MTT 60/10	60kVA	8'	60 24	41x83x151	80x83x180	230+675	1016147	" 20.400,00
MTT 80/10	80kVA	7'	60 24	"	"	230+675	1016148	" 22.200,00
MTT 100/10	100kVA	10'	60 38	"	"	230+1090	1016149	" 24.000,00
MTT 120/10	120kVA	10'	60 65	"	"	230+1450	1016150	" 30.000,00

Fornibili modelli fino a 200kV.

Possibilità di autonomia personalizzata.

ASSISTENZA TECNICA QUALIFICATA

Available models up to 200kVA.

Other battery cabinet available on request.

QUALIFIED TECHNICAL ASSISTANCE

CAP. 48

STABILIZZATORI ELETTRONICI DI TENSIONE
MONOFASE 230Vac - STATO SOLIDO
COMPLETAMENTE AUTOMATICO
IP21
A.C. ELECTRONIC VOLTAGE STABILIZERS
MONO 230Vac - SOLID STATE
FULL AUTOMATIC

- Ampio range di stabilizzazione
- **SENZA MANUTENZIONE**
- Vita operativa illimitata
- Stabilizzazione in tempo reale
- Ottima precisione di uscita

ESTAB 2500C

ESTAB 8000

- Wide stabilization input range
- **MAINTENANCE FREE**
- Very long operative life
- High speed regulation
- Excellent output stability

NEW! LCD display multimeter

NOVITÀ! Strumento con display LCD

Mod. ESTAB 1000B	Potenza	1000VA	Input current	4,5A	[cod. 1001016].....Euro	480,00
Mod. ESTAB 2500C	Power	2500VA	"	11A	[cod. 1001029].....	800,00
Mod. ESTAB 4000C	"	4000VA	"	18,2A	[cod. 1001032].....	1.050,00
Mod. ESTAB 8000	"	8000-9000VA max	"	36A	[cod. 1001024].....	1.480,00

 Ingresso: 170-270V 50Hz, Uscita 230V ± 2.5% 50Hz.
 Morsettiera sul frontale, robusta meccanica IP21

 Input: 170-270V 50Hz, Output 230V ± 2.5% 50Hz.
 Protected terminal block, strong enclosure IP21

CAP. 49

CONDIZIONATORI DI RETE 230Vac
STABILIZZATORI DI TENSIONE
ISOLAMENTO GALVANICO DI SICUREZZA
IP21
A.C. LINE CONDITIONER 230Vac
VOLTAGE STABILIZERS
BUILT-IN GALVANIC SEPARATOR
SENZA MANUTENZIONE

Scaricatori antifulmine inclusi

Doppia protezione:

stabilizzano la tensione e filtrano i disturbi di rete

MAINTENANCE FREE

Spark lightning protection included

Double protection:

voltage stabilization and noise filtering

NOVITÀ! Strumento con display LCD

NEW! LCD display multimeter

Mod. ESTAB 1000SC	Potenza	1000VA	Input current	4,5A	[cod. 1001031].....Euro	840,00
Mod. ESTAB 2000SC	Power	2000VA	"	11A	[cod. 1001035].....	1.250,00

 Tensione di prova di isolamento: 7kV.
 Ingresso: 170-270V 50Hz - Uscita 230V ± 2.5% 50Hz

 Insulation voltage test: 7kV.
 Input: 170-270V 50Hz - Output 230V ± 2.5% 50Hz

CAP. 50

STABILIZZATORI DI TENSIONE
TRIFASE 400Vac + N
ELETTRONICI STATO SOLIDO
Controllo a fasi indipendenti
IP21
VOLTAGE STABILIZERS
THREE PHASES 400Vac + N
FULL ELECTRONIC SOLID STATE
Independent phase regulation
COMPLETAMENTE AUTOMATICI
OPERATIVITÀ ILLIMITATA
SENZA MANUTENZIONE

3 ESTAB

3 ESTAB RACK
FULL AUTOMATIC
ALWAYS OPERATIVE
MAINTENANCE FREE

 Ingresso 400V -27% +23% 50Hz
 Uscita 400V ± 2.5% 50Hz.

 Input 400V -27% +23% 50Hz
 Output 400V ± 2.5% 50Hz.

Mod. 3 ESTAB 2500	Potenza	7,5kVA	Input current	11A (1PH)	[cod. 1001027].....Euro	2.700,00
Mod. 3 ESTAB 4000	Potenza	12kVA	"	18A (1PH)	[cod. 1001026].....Euro	3.300,00
Mod. 3 ESTAB 8000	"	24kVA	"	36A (1PH)	[cod. 1001028].....	4.700,00

Fornitura standard:

3 unità stabilizzatrici con connessione di installazione trifase.

Standard delivery:

3 single phases stabilizer connected by wiring box.

Opzione:

 Armadio di alloggiamento RACK 19U
 con wattmetri IN/OUT (L1,L2,L3)

Optional:

 19 UNITS RACK cabinet 19".....Euro **1.100,00**
 with wattmeters IN/OUT (L1,L2,L3)

CAP. 51

STABILIZZATORI DI TENSIONE TRIFASE
400Vac + N - ELETTROMECCANICI
 Controllo medio

IP21
THREE PHASES VOLTAGE STABILIZERS
400Vac + N - ELECTROMECHANICAL
 Average control

NOVITÀ! FULL PROTECTION kit incluso:

- Protezione sovracorrente in uscita
- SLP surge protection
- Remote control su relè (per bassa/alta tensione, fase mancante)
- Multimetro digitale

NEW! FULL PROTECTION kit included:

- Output overcurrent protection
- SLP surge protection
- Monitoring relay (under/over voltage missing phase)
- Digital multimeter

Mod.	Potenza	45kVA	Input current	65A	[cod. 1001033]....Euro	9.200,00
Mod. BST-T45	Potenza	45kVA	Input current	65A	[cod. 1001033]....Euro	9.200,00
Mod. BST-T60	Power	60kVA	"	87A	[cod. 1001030].... "	11.800,00
new Mod. BST-T90	"	90kVA	"	130A	[cod. 1001036].... "	13.500,00
Mod. BST-T110	"	110kVA	"	158A	[cod. 1001037].... "	15.800,00
Mod. BST-T150	"	150kVA	"	216A	[cod. 1001038].... "	24.000,00
new Mod. BST-T220	"	220kVA	"	318A	[cod. 1001039].... "	34.000,00
new Mod. BST-T250	"	250kVA	"	360A	[cod. 1001040].... "	36.000,00
new Mod. BST-T300	"	300kVA	"	430A	[cod. 1001041].... "	38.000,00

 Ingresso 400V ± 15%, Uscita 400V ± 1.5% 50Hz
 (disponibili ±20% IN, OUT ±2,5% su richiesta)

 Input 400V ± 15%, Output 400V ± 1.5% 50Hz
 (available on request ±20% IN, OUT ±2,5%)

VERSIONI -IR CONTROLLO A FASI INDIPENDENTI
 IN ±15%, OUT ±1%: sovrapprezzo +15%

-IR VERSIONS INDEPENDENT PHASE REGULATION
 IN ±15%, OUT ±1%: overprice +15%

CAP. 52

SEPARATORI TRASFORMATORI DI RETE
IP21
SCHERMO ELETTROSTATICO

 Isolano la rete dal carico
 Alta protezione contro caduta fulmini

GALVANIC SEPARATOR TRANSFORMERS
ELECTROSTATIC BARRIER FILTER

 Main - load insulation
 High storm lightning protection

NOVITÀ! Strumento con display LCD
Applicazioni: sicurezza operatori ed elettromedicali, filtri per rete inquinata e filtro antisturbo.

NEW! LCD display multimeter
Applications: medical equipment, safety, insulation and noise filter.

Mod.	Potenza	1000VA	Insulation test	8kV	[cod. 1017002].....Euro	400,00
Mod. TSR 1000	Potenza	1000VA	Insulation test	8kV	[cod. 1017002].....Euro	400,00
Mod. TSR 2000	Power	2000VA	"	"	[cod. 1017006]..... "	540,00
Mod. TSR 3000	"	3000VA	"	"	[cod. 1017003]..... "	700,00
Mod. TSR 4000	"	4000VA	"	"	[cod. 1017004]..... "	850,00
Mod. TSR 8000	"	8000VA	"	"	[cod. 1017005]..... "	1.670,00

 INPUT 230V 50Hz 1PH
 OUTPUT 230V 50Hz 1PH

CAP. 53

TRASFORMATORI DI ISOLAMENTO GALVANICO

ALTA PROTEZIONE CONTRO CADUTA FULMINI

INPUT INSULATION TRANSFORMERS

HIGH SPARK STORM PROTECTION

La più valida protezione di ingresso per alimentatori switching

INSTALLAZIONE BARRA DIN

- Finitura open-frame
- Morsettiera protetta IN/OUT
- Clip metallica



270-340VA



450-490VA

The best and efficient input protection for all power supplies

DIN RAIL BAR INSTALLATION

- Open-frame enclosure
- Protected IN/OUT terminal block
- Metallic clip

Mod.	Potenza	270VA	Insulation test	6kV	[cod. 1017007].....Euro	90,00
Mod. TSR 270	Potenza	270VA	Insulation test	6kV	[cod. 1017007].....Euro	90,00
Mod. TSR 340	Power	340VA	"	6kV	[cod. 1017008]..... "	100,00
Mod. TSR 450	"	450VA	"	3,5kV	[cod. 1017009]..... "	190,00
Mod. TSR 900	"	900VA	"	3,5kV	[cod. 1017010]..... "	250,00

 INPUT 230V 50Hz
 OUTPUT 230V 50Hz

 Disponibili versioni con rete di ingresso 110Vac, 400Vac
 OUT 230Vac

 Available versions with input main 110Vac, 400Vac
 OUT 230Vac

CAP. 54

ESTENSORI DI CAMPO PER TELEFONIA CELLULARE
2G - 4G LTE - 5G

 AFFIDABILI - FUNZIONALI - CONVENIENTI
 CERTIFICATI CE - Dir. 2014/53/UE

CELLULAR TELEPHONE EXTENDERS
2G - 4G LTE - 5G

 RELIABILITY - OPERATIVITY - GOOD VALUE
 CE CONFORMITY - Dir. 2014/53/UE

Banda / Band	Modello Model	Product Code	Parti fornite Delivery hardware	Listino Price list	Versione Version	Copertura Interna Indoor coverage
BT14 BAND 20 800MHz 4G LTE	BT14	100301053	14 - 15 - 4 - 11 - 16	€ 420,00	Mono-directional	300-1000m ²
	BT14/C7	1003010110	14 - 15 - 4 - 12 - 16			
	BT14/CT4	100301076	14 - 15 - 9 - 11 - 16	€ 820,00	Multi-directional	300-1000m ²
	BT14/CT4/C7	1003010129	14 - 15 - 9 - 12 - 16			
BT10 BAND 8 900MHz 2G/3G	BT10	1003096	14 - 15 - 4 - 11 - 16	€ 420,00	Mono-directional	200-300m ²
	BT10/C7	1003010128	14 - 15 - 4 - 12 - 16			
	BT10-OM	1003095	14 - 15 - 10 - 11 - 16	€ 400,00	Omni-directional	100-200m ²
	BT10-OM/C7	1003010103	14 - 15 - 10 - 12 - 16			
BT20 N-DCS BAND 3 1800MHz 4G LTE - LTE+	BT20 N-DCS	100301072	14 - 15 - 1 - 11 - 16	€ 470,00	Mono-directional	200-300m ²
	BT20 N-DCS/C7	1003010130	14 - 15 - 1 - 12 - 16			
	BT20 N-DCS/OM	100301081	14 - 15 - 10 - 11 - 16	€ 450,00	Omni-directional	100-200m ²
	BT20 N-DCS/OM/C7	1003010131	14 - 15 - 10 - 12 - 16			
BT15 BAND 1 2100MHz 3G/4G	BT15	10030104	14 - 15 - 1 - 11 - 16	€ 470,00	Mono-directional	200-300m ²
	BT15/C7	1003010132	14 - 15 - 1 - 12 - 16			
	BT15-OM	10030105	14 - 15 - 10 - 11 - 16	€ 450,00	Omni-directional	100-200m ²
	BT15-OM/C7	1003010133	14 - 15 - 10 - 12 - 16			
BT20 DUAL BAND 1+8 900+2100MHz 2G/3G/4G	BT20 DUAL	100301016	13 - 15 - 1 - 11 - 16	€ 970,00	Mono-directional	800-1500m ²
	BT20 DUAL/C7	1003010104	13 - 15 - 1 - 12 - 16			
	BT20 DUAL/OM	100301018	13 - 15 - 10 - 11 - 16	€ 950,00	Omni-directional	400-800m ²
	BT20 DUAL/OM/C7	100301014	13 - 15 - 10 - 12 - 16			
	BT20 DUAL/COL2	100301019	13 - 15 - 5 - 11 - 16	€ 1.230,00	Collinear 2 panels	1000-1500m ²
	BT20 DUAL/COL2/C7	100301013	13 - 15 - 5 - 12 - 16			
	BT20 DUAL/COL4	100301020	13 - 15 - 6 - 11 - 16	€ 1.530,00	Collinear 4 panels	1000-2000m ²
	BT20 DUAL/COL4/C7	100301097	13 - 15 - 6 - 12 - 16			
BT20 DUAL G-D BAND 8+3 900+1800MHz 2G/3G/4G	BT20 DUAL G-D	100301024	13 - 15 - 1 - 11 - 16	€ 990,00	Mono-directional	800-1500m ²
	BT20 DUAL G-D/C7	1003010111	13 - 15 - 1 - 12 - 16			
	BT20 DUAL G-D/OM	100301017	13 - 15 - 10 - 11 - 16	€ 970,00	Omni-directional	500-700m ²
	BT20 DUAL G-D/OM/C7	1003010107	13 - 15 - 10 - 12 - 16			
	BT20 DUAL G-D/COL2	100301021	13 - 15 - 5 - 11 - 16	€ 1.250,00	Collinear 2 panels	1000-1500m ²
	BT20 DUAL G-D/COL2/C7	1003010102	13 - 15 - 5 - 12 - 16			
	BT20 DUAL G-D/COL4	100301042	13 - 15 - 6 - 11 - 16	€ 1.550,00	Collinear 4 panels	1000-1800m ²
	BT20 DUAL G-D/COL4/C7	100301097	13 - 15 - 6 - 12 - 16			
BT20 DCS BAND 3 1800MHz 4G LTE - LTE+	BT20 DCS	100301037	13 - 15 - 1 - 11 - 16	€ 660,00	Mono-directional	800-1500m ²
	BT20 DCS/C7	1003010135	13 - 15 - 1 - 12 - 16			
	BT20 DCS/COL2	100301056	13 - 15 - 5 - 11 - 16	€ 900,00	Collinear 2 panels	900-1500m ²
	BT20 DCS/COL2/C7	1003010136	13 - 15 - 5 - 12 - 16			
	BT20 DCS/COL4	100301095	13 - 15 - 6 - 11 - 16	€ 1.200,00	Collinear 4 panels	900-1800m ²
BT20 DCS/COL4/C7	1003010137	13 - 15 - 6 - 12 - 16				
BT20 LTE BAND 7 2600MHz 4G LTE - LTE+	BT20 LTE	100301041	13 - 15 - 2 - 11 - 16	€ 980,00	Mono-directional	600-800m ²
	BT20 LTE/C7	1003010138	13 - 15 - 2 - 12 - 16			
	BT20 LTE/COL2	100301047	13 - 15 - 7 - 11 - 16	€ 1.240,00	Collinear 2 panels	800-1200m ²
	BT20 LTE/COL2/C7	1003010139	13 - 15 - 7 - 12 - 16			
	BT20 LTE/COL4	100301052	13 - 15 - 8 - 11 - 16	€ 1.540,00	Collinear 4 panels	1000-1500m ²
BT20 LTE/COL4/C7	1003010140	13 - 15 - 8 - 12 - 16				

SMART LINE

PROFESSIONAL LINE

I ripetitori estensori di campo Microset sono apparati molto affidabili, efficienti e di sicuro funzionamento.

Si utilizzano per trasportare il segnale dall'esterno degli edifici, dove è presente ed operativo, all'interno dove è scarso o assente oppure tra esterno - esterno (in aree limitate).

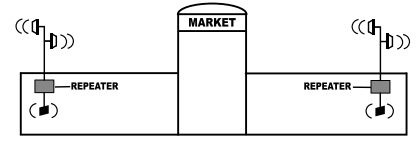
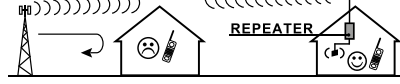
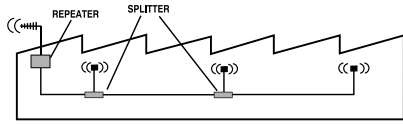

Applicazioni: abitazioni, uffici, ristoranti, industrie, alberghi, gallerie, zone montane e di basso segnale.

The Microset repeaters field extenders are very reliable and efficient equipments, useful to repeat the mobile telephone signal from outdoor (roof) where it is operative to indoor of the building where low level is absent, also outdoor-outdoor in shadow limited areas.

Applications: houses, offices, restaurants, factories, hotels, galleries, mountain and countryside low signal areas.

GAMMA AMPLIATA:

• SMART line:

Mono band, **medie coperture**, ottimo rapporto qualità prezzo, amplificatore **55dB**

• PROFESSIONAL line:

Mono e dual band, combinabili in sistemi multibanda, **ampie coperture**, amplificatore **65dB**

NEW PRODUCTS:

• SMART line:

Mono band, **medium coverage**, excellent value for money, amplifier **55dB**

• PROFESSIONAL line:

Mono e dual band, multiband systems facility, **big coverage**, amplifier **65dB**

ANTENNE ESTERNE

DIRETTIVE - DIRECTIONAL



1 MD 14 4-bands
800 - 900 - 1800 - 2100MHz



2 M15-LTE
2600MHz

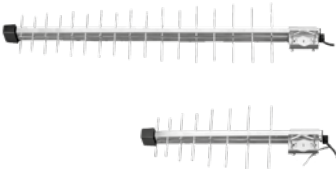

3 LOG10
900MHz



4 LOG5
800 - 900MHz

OUTDOOR ANTENNAS

MULTIDIREZIONALI - MULTIDIRECTIONAL



6 COL4 4-bands
800 - 900 - 1800 - 2100MHz

8 COL4-LTE
2600MHz

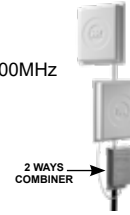

5 COL2 4-bands
800 - 900 - 1800 - 2100MHz

7 COL2-LTE
2600MHz

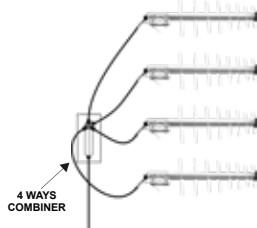

9 CT4
800 - 900MHz



10 MD 6 OMNI
900 - 1800 - 2100MHz

ANTENNE INTERNE



11 MP10-4
800 - 900 - 1800
2100 - 2600MHz
PANNELLO A PARETE
WALL PANEL

INDOOR ANTENNAS



12 C7-LTE
800 - 900 - 1800
2100 - 2600MHz
OMNI A SOFFITTO
CEILING OMNI

AMPLIFICATORE - AMPLIFIER



Professional
60-65dB
conn. TNC plugs



Smart
50-55dB
conn. TNC plugs



Alimentatore 110-220Vac
Adaptor 110-220Vac



n. 2 Cavi coassiali 10mt
con connettori assemblati
n. 2 units 10mt Coax cable
with assembled connectors

SISTEMI MULTIBANDA 4G
VERSIONI COL2/COL4 AD ALTA EFFICIENZA
4G MULTIBAND SYSTEMS
HIGH GAIN COL2/COL4 VERSION

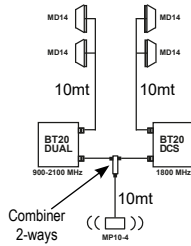
3-BAND 2G-4G LTE

- ① **3 BAND COL2 900-1800-2100** [cod. 100301088]
 band 8 (900MHz), 1 (2100MHz), 3 (1800MHz)
 composto da / including:
 BT20 DUAL/COL2
 BT20 DCS/COL2 con / with COMBINER 2 WAYS
 Euro **2.050,00**

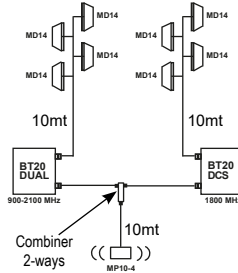

- ② **3 BAND COL4 900-1800-2100** [cod. 1003010118]
 band 8 (900MHz), 1 (2100MHz), 3 (1800MHz)
 composto da / including:
 BT20 DUAL/COL4
 BT20 DCS/COL4 con / with COMBINER 2 WAYS
 Euro **2.650,00**

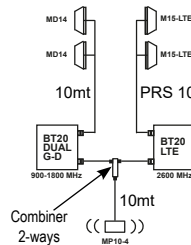

- ③ **3 BAND COL2 900-1800-2600** [cod. 1003010141]
 band 8 (900MHz), 3 (1800MHz), 7 (2600MHz)
 composto da / including:
 BT20 DUAL G-D/COL2
 BT20 LTE/COL2-LTE con / with COMBINER 2 WAYS
 Euro **2.410,00**

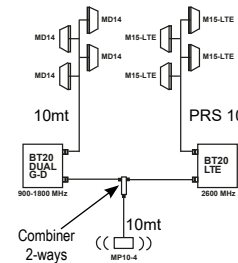
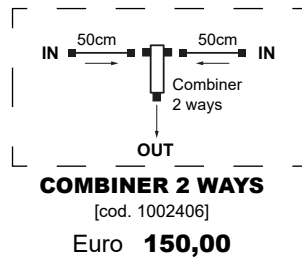

- ④ **3 BAND COL4 900-1800-2600** [cod. 1003010142]
 band 8 (900MHz), 3 (1800MHz), 7 (2600MHz)
 composto da / including:
 BT20 DUAL G-D/COL4
 BT20 LTE/COL4-LTE con / with COMBINER 2 WAYS
 Euro **3.010,00**

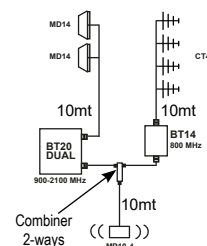

- ⑤ **3 BAND COL2 800-900-2100** [cod. 100301089]
 band 20 (800MHz), 8 (900MHz), 1 (2100MHz)
 composto da / including:
 BT20 DUAL/COL2
 BT14-CT4 con / with COMBINER 2 WAYS
 Euro **1.970,00**

UPGRADE DI IMPIANTO ESISTENTE
UPGRADE EXISTING EXTENDER

- B3: BT20 DCS/COL2 with combiner**
 [cod. 100301065].....Euro **900,00**
BT20 DCS/COL4 with combiner
 [cod. 100301070].....Euro **1.200,00**
B7: BT20 LTE/COL2 with combiner
 [cod. 100301038].....Euro **1.240,00**
BT20 LTE/COL4 with combiner
 [cod. 100301043].....Euro **1.540,00**
B20: BT 14/CT4 with combiner
 [cod. 100301075].....Euro **820,00**

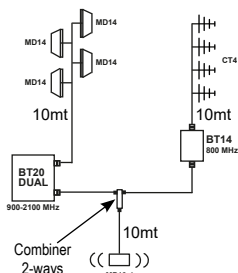

- ⑥ **3 BAND COL4 800-900-2100** [cod. 1003010123]
 band 20 (800MHz), 8 (900MHz), 1 (2100MHz)
 composto da / including:
 BT20 DUAL/COL4
 BT14-CT4 con / with COMBINER 2 WAYS
 Euro **2.270,00**

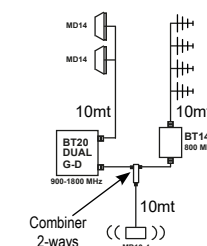

- ⑦ **3 BAND COL2 800-900-1800** [cod. 100301090]
 band 20 (800MHz), 8 (900MHz), 3 (1800MHz)
 composto da / including:
 BT20 DUAL G-D/COL2
 BT14-CT4 con / with COMBINER 2 WAYS
 Euro **1.990,00**

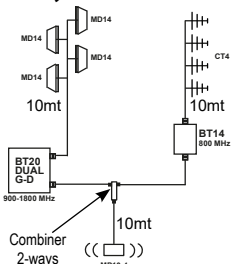

- ⑧ **3 BAND COL4 800-900-1800** [cod. 1003010112]
 band 20 (800MHz), 8 (900MHz), 3 (1800MHz)
 composto da / including:
 BT20 DUAL G-D/COL4
 BT14-CT4 con / with COMBINER 2 WAYS
 Euro **2.290,00**

CAP. 56

SISTEMI MULTIBANDA 4G
VERSIONI COL2/COL4 AD ALTA EFFICIENZA
4G MULTIBAND SYSTEMS
HIGH GAIN COL2/COL4 VERSION

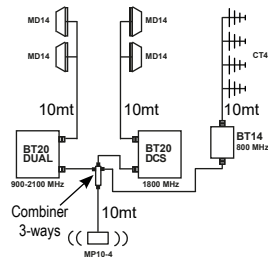
4-BAND 2G-4G LTE

- 9 4 BAND COL2 800-900-1800-2100** [cod. 100301092]
band 20 (800MHz), 8 (900MHz), 3 (1800MHz), 1 (2100MHz)
 composto da / including:
 BT20 DUAL/COL2
 BT14-CT4
 BT20 DCS/COL2 con / with COMBINER 3 WAYS
 Euro **2.800,00**

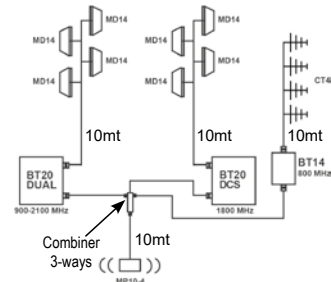

- 10 4 BAND COL4 800-900-1800-2100** [cod. 1003010125]
band 20 (800MHz), 8 (900MHz), 3 (1800MHz), 1 (2100MHz)
 composto da / including:
 BT20 DUAL/COL4
 BT14-CT4
 BT20 DCS/COL4 con / with COMBINER 3 WAYS
 Euro **3.400,00**

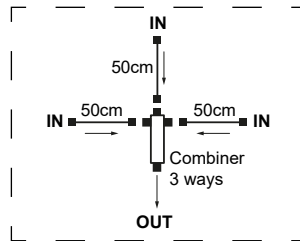
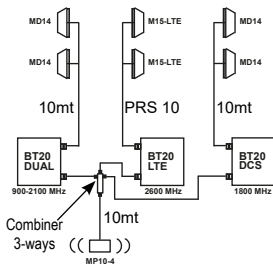
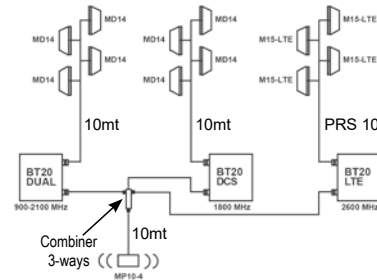
COMBINER 3 WAYS
 [cod. 1002407]
 Euro **180,00**

- 11 4 BAND COL2 900-1800-2100-2600** [cod. 100301094]
band 8 (900MHz), 3 (1800MHz), 1 (2100MHz), 7 (2600MHz)
 composto da / including:
 BT20 DUAL/COL2
 BT20 DCS/COL2
 BT20 LTE/COL2-LTE con / with COMBINER 3 WAYS
 Euro **3.220,00**

- 12 4 BAND COL4 900-1800-2100-2600** [cod. 1003010126]
band 8 (900MHz), 3 (1800MHz), 1 (2100MHz), 7 (2600MHz)
 composto da / including:
 BT20 DUAL/COL4
 BT20 DCS/COL4
 BT20 LTE/COL4-LTE con / with COMBINER 3 WAYS
 Euro **4.120,00**

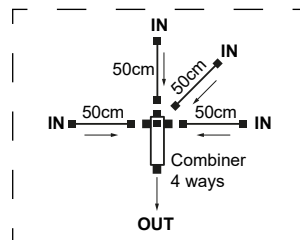
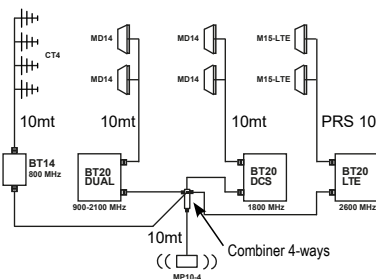
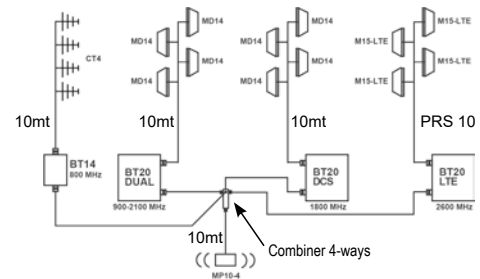
5-BAND 2G-4G LTE

COMBINER 4 WAYS
 [cod. 1003010115]
 Euro **210,00**

- 13 5 BAND COL2 800-900-1800-2100-2600** [cod. 1003010113]
band 20 (800MHz), 8 (900MHz), 3 (1800MHz), 1 (2100MHz), 7 (2600MHz)
 composto da / including:
 BT20 DUAL/COL2
 BT20 LTE/COL2-LTE
 BT14-CT4
 BT20 DCS/COL2 con / with COMBINER 4 WAYS
 Euro **3.990,00**

- 14 5 BAND COL4 800-900-1800-2100-2600** [cod. 1003010124]
band 20 (800MHz), 8 (900MHz), 3 (1800MHz), 1 (2100MHz), 7 (2600MHz)
 composto da / including:
 BT20 DUAL/COL4
 BT20 LTE/COL4-LTE
 BT14-CT4
 BT20 DCS/COL4 con / with COMBINER 4 WAYS
 Euro **4.890,00**

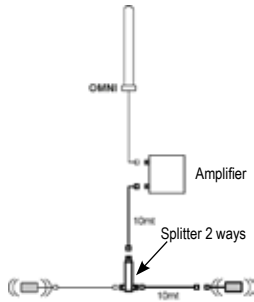
CAP. 57

**KIT SPLITTER DI ESPANSIONE
 PER INTERNO**

 Mod. **KSD2**.....Euro **300,00**
 [cod. 100301030]

 Mod. **KSD2/C7**.....Euro **320,00**
 [cod. 100301077]

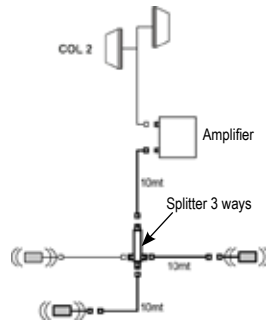
 Materiale incluso - *Delivery hardware*:
 1 x Splitter 2 vie - ways
 2 x 10mt cavo coassiale - coax cable
 1 x Antenna interna - indoor antenna
 MP10-4 or C7-LTE

**EXPANDING KIT SPLITTER
 INDOOR INSTALLATION**

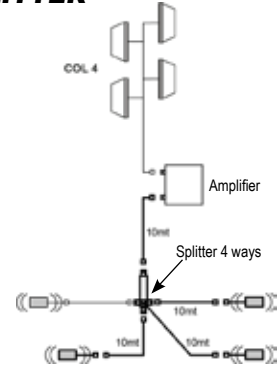
 Mod. **KSD3**.....Euro **460,00**
 [cod. 100301032]

 Mod. **KSD3/C7**.....Euro **500,00**
 [cod. 100301078]

 Materiale incluso - *Delivery hardware*:
 1 x Splitter 3 vie - ways
 3 x 10mt cavo coassiale - coax cable
 2 x Antenna interna - indoor antenna
 MP10-4 or C7-LTE

 Mod. **KSD4**.....Euro **665,00**
 [cod. 10030115]

 Mod. **KSD4/C7**.....Euro **725,00**
 [cod. 100301079]

 Materiale incluso - *Delivery hardware*:
 1 x Splitter 4 vie - ways
 4 x 10mt cavo coassiale - coax cable
 3 x Antenna interna - indoor antenna
 MP10-4 or C7-LTE

CAP. 58

**PROLUNGHE E CAVI COASSIALI
 PRECABLATI a bassa attenuazione**
CAVO COASSIALE STANDARD TNC m-m

Mod. COAX 1	[cod. 4041527].....Euro	40,00
Mod. COAX 5	[cod. 4041526]..... "	48,00
Mod. COAX 10	[cod. 4041483]..... "	55,00
Mod. COAX 15	[cod. 40414100]..... "	80,00

**Low loss ASSEMBLED EXTENSION
 COAXIAL CABLES UNITS**
STANDARD COAX CABLE TNC m-m

Lunghezza	1 mt	Diam. Ø5mm	Attenuazione	1.0 - 1.4 dB
Length	5 mt	"	Loss	2.0 - 2.8 dB
"	10 mt	"	"	3.6 - 5.5 dB
"	15 mt	"	"	5.8 - 7.8 dB

PROLUNGHE CAVO ANTENNA TNC m-f

Mod. PR 5	[cod. 100301045].....Euro	55,00
Mod. PR 10	[cod. 1003089]..... "	75,00
Mod. PR 20	[cod. 1003090]..... "	120,00
Mod. PR 30	[cod. 1003091]..... "	170,00

EXTENSION COAX CABLES UNITS TNC m-f

Lunghezza	5 mt	Diam. Ø10mm	Attenuazione	0.6 - 1.1 dB
Length	10 mt	"	Loss	1.3 - 2.0 dB
"	20 mt	"	"	2.6 - 4.1 dB
"	30 mt	"	"	3.9 - 6.0 dB

CAVI COASSIALI A BASSA PERDITA TNC m-m

Mod. PRS 1	[cod. 100301012].....Euro	40,00
Mod. PRS 5	[cod. 100301048]..... "	55,00
Mod. PRS 10	[cod. 100301049]..... "	75,00
Mod. PRS 15	[cod. 100301057]..... "	98,00
Mod. PRS 20	[cod. 100301050]..... "	120,00
Mod. PRS 25	[cod. 100301066]..... "	135,00
Mod. PRS 30	[cod. 100301051]..... "	170,00
Mod. PRS 40	[cod. 100301082]..... "	225,00

LOW LOSS CONNECTION CABLES TNC m-m

Lunghezza	1 mt	Diam. Ø10mm	Attenuazione	0.1 - 0.2 dB
Length	5 mt	"	Loss	0.6 - 1.1 dB
"	10 mt	"	"	1.3 - 2.0 dB
"	15 mt	"	"	2.0 - 3.2 dB
"	20 mt	"	"	2.6 - 4.1 dB
"	25 mt	"	"	3.4 - 4.9 dB
"	30 mt	"	"	3.9 - 6.0 dB
"	40 mt	"	"	5.2 - 7.9 dB

CAVI COASSIALI BASSISSIMA ATTENUAZIONE TNC m-m
 Cavo LMR 600, per microwave e lunghe metrature

Mod. PRL 10	[cod. 10030122].....Euro	260,00
Mod. PRL 20	[cod. 10030123]..... "	380,00
Mod. PRL 30	[cod. 10030124]..... "	480,00
Mod. PRL 40	[cod. 10030125]..... "	590,00
Mod. PRL 50	[cod. 10030126]..... "	700,00
Mod. PRL 60	[cod. 10030127]..... "	830,00

VERY LOW LOSS COAX CABLES UNITS TNC m-m
 LMR 600 coax cable, microwave and long size applications

Lunghezza	10 mt	Diam. Ø15mm	Attenuazione	0.7 - 1.2 dB
Length	20 mt	"	Loss	1.4 - 2.4 dB
"	30 mt	"	"	2.1 - 3.6 dB
"	40 mt	"	"	2.8 - 4.8 dB
"	50 mt	"	"	3.5 - 6.0 dB
"	60 mt	"	"	4.2 - 7.2 dB

Diametro connettore - Connectors size: Ø 19mm

Raggio minimo di curvatura - Bend radius: 40 mm

CAP. 59

ANTENNE INTERNE
2G/3G/4G/5G/DECT
INDOOR ANTENNAS

Mod. C7-LTE [cod. 4041495A-LTE].....Euro	125,00	Da soffitto - Ceiling	360°	850-960/1700-2700MHz	gain 7-8dBi	TNC-F
Mod. MP10-4 [cod. 4041488B].....	95,00	Da parete - Wall	160°-180°	"	" 10-12dBi	"
Mod. MP10-4S [cod. 4041488S].....	115,00	Wall Waterproof	"	"	" 10-12dBi	"

CAP. 60

ANTENNE DA TETTO
2G - 3G - 4G - 5G
ROOF ANTENNAS

Mod. LOG 10 [cod. 4041466].....Euro	110,00	Directional	20°	860-980MHz	gain 14dBi	TNC-F
Mod. LOG 5 [cod. 4041475].....	100,00	Directional	70°	790-960MHz	" 8dBi	"
Mod. MD6 [cod. 4041426].....	110,00	Omni	360°	850-960/1700-2200/3400-3600MHz	" 6dBi	"
Mod. MD14 [cod. 4041482B].....	140,00	Panel	70°	730-960/1700-2200/3400-3800MHz	" 14dBi	"
Mod. M15-LTE [cod. 4041495F].....	130,00	Panel	50-60°	2300-2700MHz	" 15dBi	"

CAP. 61

ANTENNE COLLINEARI AD ALTO GUADAGNO

Le antenne collineari **COL2**, **COL4** e **CT4** sono utilizzabili per incrementare il basso segnale esterno, per compensare le attenuazioni dei lunghi cavi e splitter. Orientabili in una sola o più direzioni verso le celle operatori.

VERY HIGH GAIN COLLINEAR ANTENNA

Collinear antenna **COL2**, **COL4** and **CT4** are useful where the outside signal is poor, to balance long cables and splitter attenuation and where it is required to operate with more providers and cells placed in different positions.



Mod. **COL 2** [cod. 1014023].....Euro **400,00**
 2 x MD14 + combiner COL2

Mod. **COL 2-LTE** [cod. 1014025]....Euro **380,00**
 2 x M15-LTE + combiner COL2

COMBINER COL 2

Gain	Radiation
14dBi	120°
16,5dBi	90°

Plug TNC-f

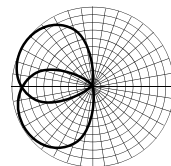

COL2
Max Radiation Pattern 120°



Mod. **COL 4** [cod. 1014024].....Euro **700,00**
 4 x MD14 + combiner COL4

Mod. **COL 4-LTE** [cod. 1014026]...Euro **660,00**
 4 x M15-LTE + combiner COL4

COMBINER COL 4

Gain	Radiation
14dBi	360°
21dBi	90°

Plug TNC-f

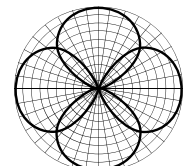

COL4
Max Radiation Pattern 360°

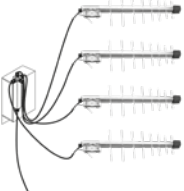

Mod. **CT 4** [cod. 4041440]....Euro **500,00**
 4 x LOG5 + combiner COL4

Gain	Radiation
10dBi	180°
14dBi	90°

Plug TNC-f



CT4
Max Radiation Pattern 180°

Mod. **COMBINER COL 2** [cod. 1014019]...Euro **120,00**
 Mod. **COMBINER COL 4** [cod. 1014022]...Euro **160,00**
 In box metallico con staffa da palo e cavi di raccordo.
 In metallic box with mast clamp and wiring cables.

CAP. 62

GENERATORE DI CONTINUITÀ

Per alimentare ripetitori sia in presenza che assenza rete.

UNINTERRUPTIBLE D.C. POWER UNITS

DC UPS for repeaters to support short and long black out.

Mod. MSB 7	Battery	7Ah	Autonomy	10-15 h [cod. 100301035].....Euro	155,00
Mod. MSB 15	"	15Ah	"	20-30 h [cod. 100301022].....	185,00

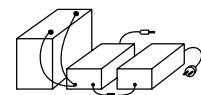

MSB 7

Includono: alimentatore, batteria 12V con cavi di connessione, convertitore 12→9Vdc oppure 12V→10-12Vdc e box IP65 contenitore stagno per esterno.

Included: charger adapter, battery 12V, DC-DC converter 12→9Vdc or 12V→10-12Vdc and waterproof box IP65 outdoor installation.

SEZIONE AMPLIFICATORI HF-VHF-UHF HAM RADIO AMPLIFIERS

CAP. 63

**AMPLIFICATORI VHF-UHF LINEARI DI POTENZA
 NUOVA GENERAZIONE**

 Tecnologia MOS power, FM-SSB, CW,
 OTTIMA LINEARITÀ, FILTRO ARMONICHE
 Commutazione automatica antenna, P.T.T.

 Mod. **SR 500** 144-148MHz in 3-12W out 500W ±1dB [cod. 10030147].....Euro **2.400,00**
 Mod. **RU 500** 430-440MHz in 10-20W out 500W ±1dB [cod. 10030146]..... " **2.400,00**
A richiesta: Banda civile e marina VHF 156-165MHz, UHF 440-460MHz.
Available: Land-marine Band VHF 156-165MHz, UHF 440-460MHz.

**VHF-UHF POWER LINEAR AMPLIFIERS
 NEW GENERATION**

 MOS power technology, FM-SSB, CW,
 GOOD LINEARITY, HARMONIC FILTER

POWER 230Vac

CAP. 64

**PREAMPLIFICATORI D'ANTENNA VHF-UHF
 BASSO RUMORE, ALTA LINEARITÀ**
FREQ. 144-148MHz (140-150MHz -3dB)

 Mod. **PR 145A** by-pass 100W gain 18dB N.F. 0,9dB [cod. 1003100].....Euro **180,00**
 Mod. **PRH145A** " 250W " 20dB " " [cod. 1003102]..... " **300,00**
FREQ. 430-440MHz (420-450MHz -3dB)

 Mod. **PR 430A** by-pass 100W gain 16dB N.F. 1dB [cod. 1003101].....Euro **210,00**
 Mod. **PRH430A** " 250W " 20dB " " [cod. 1003103]..... " **320,00**
**VHF-UHF ANTENNA PREAMPLIFIERS
 LOW NOISE, HIGH LINEARITY**

PR 430A



PRH 430A

CAP. 65

**CARICHI FITTIZZI D'ANTENNA 50Ω
 FREQUENZA 0-1000MHz**

 Mod. **CF 30** potenza applicabile 30W [cod. 10020111].....Euro **70,00**
 Mod. **CF 300** power load 250W - 300W max [cod. 1002153]..... " **185,00**
 Mod. **CF 800** " " 800W - 900W max [cod. 1002211]..... " **430,00**
**50Ω ANTENNA DUMMY LOAD
 FREQUENCY DC to 1000MHz**

 Connettore N-femmina, SWR 1,5:1 tip., ottima dissipazione del calore.
 Plug N-female, SWR 1,5:1 typ., good temperature dissipation.

 I DATI E COSTI SONO INDICATIVI E POSSONO VARIARE SENZA PREAVVISO.
 TUTTI I DIRITTI RISERVATI.

 SPECIFICATIONS AND PRICES COULD CHANGE WITHOUT NOTICE.
 ALL RIGHT RESERVED.

Rivenditore - Your local distributor



HEAD QUARTER:

MICROSET INT Srl
 Via A. Peruch 64 - 33077 Sacile (Pordenone)
 ITALY

@ info@microset.net

www.microset.net

(+39) 0434 - 72459



www.microset.net